



Smart home and building solutions.
Global. Secure. Connected.

KNX Secure



JOURNAL 1 | 2018

**Maximum protection
for smart homes and buildings**
KNX Secure put into practice
New KNX Secure Products
**Easy Configuration
of KNX Secure Products in ETS**



Embedded

Smart

Wireless

**ETS5 now available with
KNX Secure functionality!**



www.knx.org

ETS5 Professional

See all ETS Apps on <https://my.knx.org> ▶ Shop

New licenses	Price	Restrictions
ETS5 Professional	€ 1000,00	
ETS5 Supplementary	€ 150,00	For Notebooks, 2 licenses maximum, only together with ETS5 Professional
ETS5 Lite	€ 200,00	maximum 20 products per project
ETS Inside	€ 160,00	
ETS Apps		For further information please visit https://my.knx.org
Upgrade licenses		
ETS4 Professional > ETS5 Professional	€ 350,00	
ETS4 Supplementary > ETS5 Supplementary	€ 110,00	
ETS4 Lite > ETS5 Lite	€ 150,00	
Educational licenses		
ETS5 Training Package	€ 1.200,00	1 x ETS5 Professional, 1 x ETS Inside, 10 x ETS5 Lite

All prices excl. VAT

Order at: <https://my.knx.org>

Editorial

- 2 Secure inside
- 3 Maximum protection for smart homes and buildings
KNX Secure offers the highest security level worldwide!



Projects

- 4 Optimal safety with good value for money
- 5 Safe integration of smart metering
- 6 Hackers have no chance in hotels
- 7 The secure way to replenish energy
- 8 How the smart home lets you speak
- 9 Cyber criminals have no chance
- 10 Secure networks of distributed facilities
- 11 Data protection of digital energy transition
- 12 Secure automation of the hotel building

System

- 13 Simple planning and configuration of KNX Secure products
ETS monitors parameters, generates security keys and safeguards projects
- 15 New KNX Secure Products

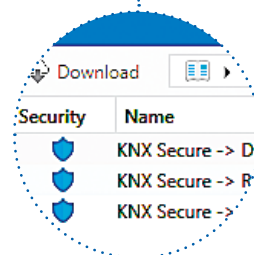

Tools

- 19 New ETS Apps

Members

- 21 New Members
- 28 New Products

Partners

- 46 National Groups
- 53 Userclub | Professionals
- 56 Training Centres
- 58 Scientific Partners

Out and About

- 63 KNX at International Conferences and Fairs
- 64 Imprint



Secure inside



Heinz Lux

CEO, KNX Association

Sciences develop theories from which verifiable statements are derived. In this context, sensory data form a complex system of statements about the reality, incessantly reviewed and only making sense as a whole.

For a long time, networked intelligent buildings were only a vision. Networks are however increasingly extending beyond the boundaries of buildings and by combining electrical engineering with information technology, there is a general higher concern for security and data integrity.

As security – that is being free of any hazards – is only a relative state, it only exists for a certain period of time under well-defined conditions. For KNX and for more than 27 years, these conditions have always been and still are: the electrical installation rules.

Today, as KNX operates at the interface between installation technology and more complex data technology, we have critically questioned and reviewed the security concerns and the demand for security.

The result is KNX Secure.

A new, compatible and future-oriented architecture for the security in building technology, as we think in buildings and in permanently changing structures and architectures. Fixed electrical installation as part of the building's infrastructure only allow limited quick updates.

With KNX, this can be much more elegantly solved.

Moreover, security can open up a new business segment with security applications and components for the professional, system integrator, designer and installer.

That's why KNX Security "lives" with KNX Secure.

“

For KNX and for more than 27 years, these conditions have always been and still are: the electrical installation rules.

”

Maximum protection for smart homes and buildings

KNX Secure offers the highest security level worldwide!

KNX is the first and only smart home and smart building standard that meets the highest security requirements in cyber security worldwide. International standardisation bodies have now officially confirmed this. With its security architecture KNX Secure, which is now standardized according to EN 50090-4-3, KNX successfully blocks hacker attacks on the digital infrastructure of networked buildings, thus ensuring maximum data protection.

No more digital break-ins!

IT security experts have long warned that hackers are increasingly targeting smart home and smart building solutions. Time and again, we hear about cases where they exploit vulnerabilities of products, interfaces or radio standards for their digital raids. "In the past, burglars would enter buildings through doors or windows. Nowadays they enter through radio and communications networks. As buildings have become increasingly digitally networked, the nature of potential dangers has also changed. Only KNX has been delivering the most appropriate responses to these", explains Franz Kammerl, President of the KNX Association.



KNX Secure is based on internationally standardised security algorithms, the AES 128 CCM

Highest encryption standards

The developers of KNX responded early on and implemented sophisticated protection concepts for networked buildings in the form of the world's leading standard. The result was the security architecture KNX Secure, which internationally also relies on security algorithms standardised according to ISO 18033-3, such as AES 128 CCM encryption, in order to effectively prevent attacks on the digital infrastructure of buildings and to achieve the highest level of data protection.

Double protection concept for twice the security

KNX Secure essentially consists of two mechanisms: KNX IP Secure protects the IP communication between the KNX installations. For this purpose, KNX IP Secure extends the IP protocol in such a way that all transferred telegrams and data are completely encrypted. At the same time, KNX Data Secure effectively protects user data, including data exchanged with the various terminals, against unauthorised access and manipulation by means of encryption and authentication. Both mechanisms can be combined and used in parallel to achieve maximum safety.

"Terminals, interfaces, radio standards and communication protocols: vulnerabilities can potentially be found everywhere. Therefore, smart homes and buildings should be secured with the most comprehensive and recognised safety standard which is also unique in the world in this area: KNX Secure!" said Franz Kammerl.

For further information, please visit: <http://KNXSecure.knx.org>

OPTIMAL SAFETY WITH GOOD VALUE FOR MONEY

Task

What threats is a KNX installation exposed to? What damage can be expected from hackers? Which parts of the installation and which applications require safety measures? System integrators face the question of economic efficiency. Components for increased safety whose parameterisation, commissioning and subsequent maintenance increase costs. The engineering firm Beyer was confronted with this problem and conceived of various safety measures adapted to the risks.

Solution

The different safety requirements of a KNX installation are represented using the example of a residential building. Using the model, safety analyses with risk evaluation are generated for the respective areas of the building. Under consideration of the cost to benefit ratio, it is possible to decide which safety category is advisable.

Implementation

The model illustrates the usual areas of a residential building:

- KNX installations with TP for self-contained, private flats,
- a public area of the KNX TP installation for an underground car park,
- a central system using a weather station and its applications
- as well as the KNX IP backbone that connects everything.

Components such as presence detectors, switch sensors and switch actuators are assigned to specific areas of the building according to their normal use.

The following devices are used for the different safety measures: three KNX IP Secure routers, a KNX Data Secure push-button interface and a KNX

Data Secure switch actuator. The safety levels are displayed using ETS5 and the analysis software Wireshark on a touch panel.

Functions

The decision regarding reasonable safety precautions can now only be made under evaluation of the possible attacks, possible damage, required investment and follow-up costs as well as possible subsequent risk:

- encryption of individual devices with a BCU password,
- prevention of physical access to the system,
- protection of the IP backbone against access with KNX IP Secure,
- authentication and encryption with KNX Data Secure KNX telegrams.

Thanks to installed ETS5 und Wireshark network analysis, visitors to the fair will gain an insight into the functions and effectiveness of the different safety modes.

Benefits

Economic safeguarding of KNX installations against unauthorised access and possible tampering through evaluation of the risks and benefits. Lower costs with optimum safety.

KNX Secure Components

- KNX IP Secure Router, Gira
- KNX Secure push-button interface, Tapko
- KNX Secure switch actuator IO 511, Weinzierl

Further KNX components

- Power supply USB367, Weinzierl
- KNX touch panel Aluna 16", TCI
- KNX switch sensor 3-gang, Gira
- KNX humidity and temperature sensor Sensato, Zennio

Ingenieurbüro Beyer
Gebäudesystemtechnik
Dipl.-Ing., Dipl.-Wirt.-Ing.
Dirk Beyer
Liegnitzer Str. 10
24537 Neumünster
+49 (0) 4321 9938-0
info@ing-beyer.de
www.ing-beyer.de

Data networks in residential buildings can be threatened in different areas. KNX Secure enables reasonable and economic protective measures.



SAFE INTEGRATION OF SMART METERING

Task

The consumption data of gas, water and electricity are confidential and must be protected from being accessed by a third party. The sensitivity of the consumption data lies in the fact that it allows conclusions to be drawn about the user behaviour of the occupants and can indicate their presence or absence. They may therefore not be transferred unprotected via publicly accessible data networks. The system integrator Elektronik Innovativ set themselves the task of protecting the transmission in the building system technology from unauthorised access.

Solution

KNX Secure has been developed primarily to meet the new requirements of safe data transmission in a smart building. KNX IP Secure and KNX Data Secure offer the possibility of transferring the KNX consumption data via a KNX TP line or KNX IP Ethernet backbone, no longer transparently but encrypted with AES.

Implementation

The represented application simulates the typical building technology with a KNX installation for management and industry as well as a residential complex. It consists of three lines with different meters for gas, water and electricity. A Hager KNX energy meter has been installed as well as a conven-

tional meter with a KNX SO interface. KNX IP Secure routers have been installed to safeguard the public KNX IP infrastructure. As the new KNX Data Secure binary interface Tapko TAI 4-gang can be used as an SO interface, the consumption data of this KNX TP application are likewise secured.

Functions

The data of different consumption meters is collected, encrypted using KNX Data Secure and made available to the central energy management system ICONAG-EnMS via secured KNX IP Secure transmission media.

Benefits

Previously, consumption data was largely transferred using a time-consuming and expensive method via proprietary data networks – not least due to the argument for guaranteeing data security. With KNX Secure, sensitive smart metering applications can now be safely integrated in a comprehensive KNX system.

KNX Secure components

- KNX IP Secure Router, Enertex
- KNX IP Data Secure binary input 4-gang, Tapko

Further KNX components

- KNX energy meter, Hager
- KNX power supply, Busch-Jaeger

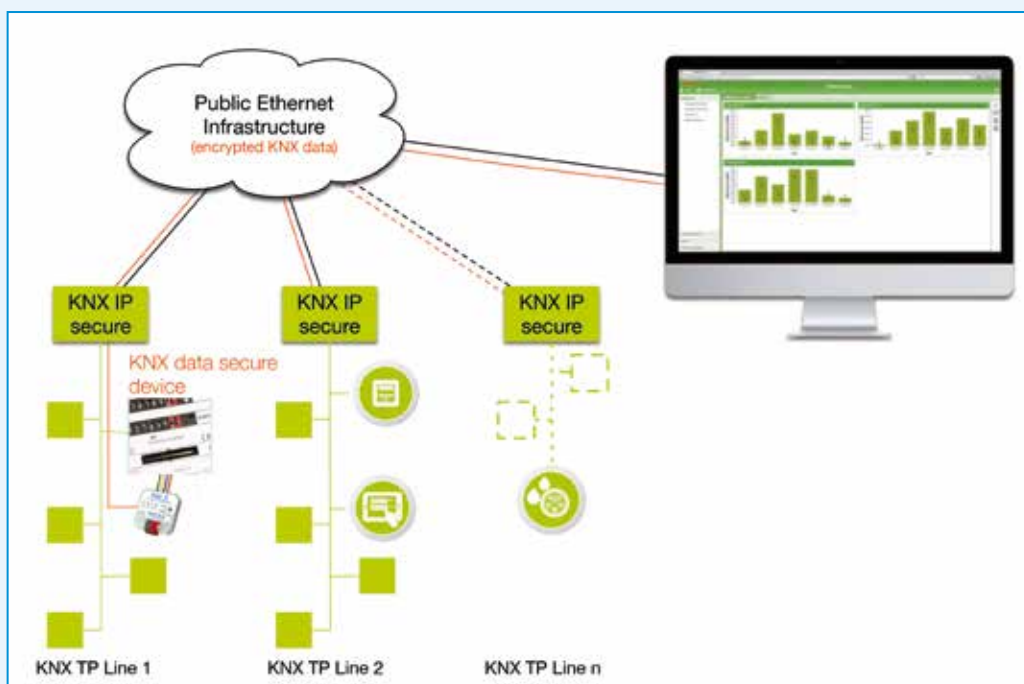

ELEKTRONIK INNOVATIV
Technische Gebäudeausrüstung - Systemtechnik

Hochstraße 12
59425 Unna
Germany
+49 (0) 2303 983 79 91
m.eudenbach@mac.com
www.mremote.de

Smart Metering as a KNX application: consumption data and its transmission via the common building network is fully protected and illegible for a third party.

HACKERS HAVE NO CHANCE IN HOTELS

Task

Hotels can sometimes have unusual guests such as those who want to hack into the building management system just for fun. They will find it difficult with KNX. A KNX installation which has been correctly implemented according to the safety regulations will not permit this. The methods employed by hackers have however become more sophisticated. The system integrator Elektronik Innovativ shows how the room functions in the hotel room and other KNX applications in the hotel can be protected against future attacks by a third party using new KNX Secure products.

Solution

Conventional protection is one aspect: you can install conventional push-buttons via binary inputs to prevent direct bus access and block telegram traffic of the room automation via the room's line. KNX Secure offers new additional protective measures which can even scupper the most intelligent criminals. Protected by KNX Data Secure and KNX IP Secure, they can neither read nor manipulate the telegram traffic nor hack into the IP infrastructure.

Implementation

The application shows for example a KNX installation in the hotel room. The room functions are each assigned a separate TP line. These special TP line couplers can only be programmed via the KNX Data Secure protocol. The TP main line is linked via KNX IP Secure routers with the primary Ethernet back-

bone. In addition to KNX devices, the project integrates the home sound system SONOS Player, intelligent Philips HUE luminaires, Alexa voice control and room control via a smartphone app. A Hager IoT gateway i.e. a central room controller makes the necessary applications available.

Functions

KNX IP routers ensure an authenticated and encrypted transmission of telegrams across areas. Only authorised persons are granted access to systems and data. Hackers can neither see nor tamper with the data communication within the rooms.

Benefits

KNX IP Secure is available for simple and cost-effective retrofitting for increased data security in hotels. Using KNX IP Data Secure, future installations can be set up which encrypt all the data from the TP line down to the transmission. This requires however the corresponding terminal devices and is therefore more appropriate for new installations.

KNX Secure components

- KNX IP Secure Router, Jung
- KNX TP Secure Line Coupler, Tapko

Further KNX components

- KNX IoT controller, Hager
- KNX room temperature controller, Jung
- KNX switch sensor, Busch-Jaeger

ELEKTRONIK INNOVATIV

Technische Gebäudeausrüstung - Systemtechnik

Hochstraße 12
59425 Unna
Germany
+49 (0) 2303 983 79 91
m.eudenbach@mac.com
www.mremote.de

*No chance for hackers:
KNX Data Secure TP line
couplers isolate the hotel room
and thus prevent unwanted
telegram traffic via the
individual room installation.*

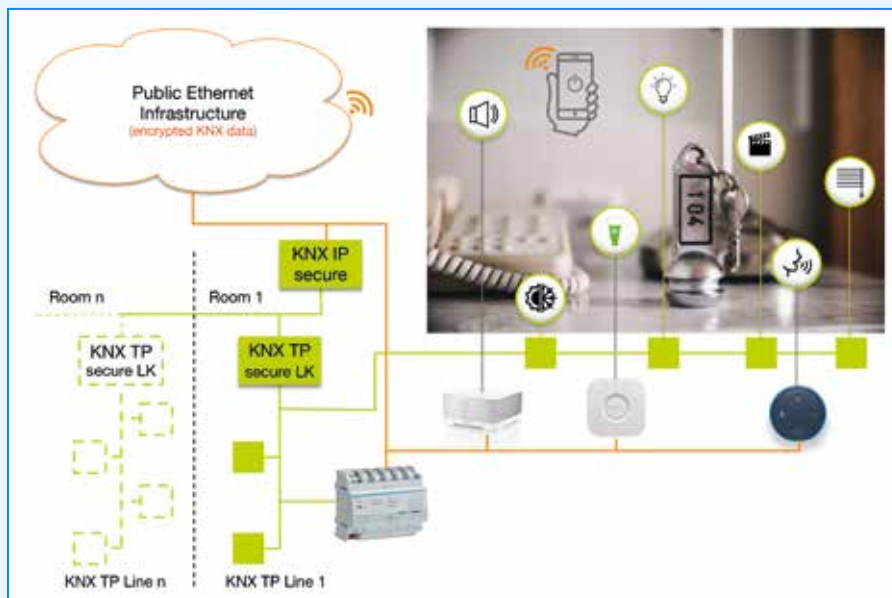

THE SECURE WAY TO REPLENISH ENERGY

Task

With the introduction of electrical mobility, charging devices have also become part of building system technology. It should be possible to integrate them in a KNX installation in the same way as other functions. The “CleverHome4you GmbH” in the KNX IoT city shows how communication with a conventional charging station can be implemented and how data about the charging processes can be monitored, managed and visualised with KNX. An essential element of the application is the protection of the communication paths and data from manipulation when importing energy.

Solution

With “Agentino Mobile”, an intelligent IoT solution is available for integration. The logic and visualisation software has been conceived for control and visualisation devices in building system technology. Specific applications for the management of charging stations can be configured using the corresponding modules.

Implementation

A charging station from Walther Werke is used to provide a realistic demonstration. A LAN connection and web browser enable communication with the KNX installation via a KNX IP router. As a KNX Secure device, the router protects against unauthorised access. The KNX system is based on the usual components and is supplemented by KNX energy meters, KNX operating and display units, a KNX RGB controller and KNX LED luminaires. Using smartphones and tablets, it is not only possible to operate the applications but also to monitor the charging processes. With the help of the Agentino

Mobile software, the data about the charging process can be used in many different ways.

Functions

With modern charging stations, there are important protocols available. It is therefore possible for example to check a right of usage, monitor a charging process and even regulate the energy import. KNX makes the corresponding evaluation units available for this purpose. The charging station can thus be controlled dependent on personal user behaviour. A visualisation with graphics and diagrams provides an overview of the amount of chargeable energy, the charging levels expressed as a percentage as well as personal usage. The available energy from a photovoltaic system can be displayed for example.

Benefits

Integration of public, semi-public and private electrical charging stations in the existing KNX installation. Charging processes can thus be visualised, monitored and controlled in many different ways. The operating interface of mobile devices such as smartphones and tablets also enables transparent recharging processes for electric cars and bicycles.

KNX Secure components

- KNX IP Secure Router, Enertex

Further KNX components

- Logic and visualisation software, Agentino
- Power supply, Enertex
- Energy meters, Enertex
- Operating and display units, iddero, VERSO, Enertex, MeTa
- LED luminaire, arcus-eds



CleverHome4you GmbH

Jochen Katzenmeier
Audifaxstr. 7
78315 Radolfzell
Germany
+49 (7732) 892 73-0
www.cleverhome4you.de

*Smart charging stations
with access protection*

HOW THE SMART HOME LETS YOU SPEAK

Task

The most intuitive way of operating and controlling building services is with your voice. The spoken word switches the lighting, raises and lowers the blinds, sets the required room temperature, activates scenes or the music system and retrieves status signals. Spoken fault signals and alarms inform you quickly and clearly. Additionally, the energy management of a photovoltaic system should also be integrated via voice control. ProKNX shows how they interact with KNX home automation and how access is restricted using KNX IP Secure.

Solution

The realKNX server package developed by ProKNX enables the operation and interrogation of the home technology in connection with the intelligent assistants on the smart home market such as Google Home, Amazon Alexa and Apple Siri. realKNX converts the KNX telegrams for the smart home loudspeaker. The configuration is carried out via ETS.

Implementation

The speech information system with realKNX integrates not only current voice assistants but makes multiroom music control and control via augmented reality available via apps for iOS, Android and browsers. In the simulated house installation, a room control device, a smoke detector, an RGB LED control and 'tunable white LED' lighting with adaptation of the LED colour temperature to the natural progression of daylight are used. As the KNX IP backbone between the residential building and the photovoltaic system is in the open, it must be protected against any possible tampering. A KNX IP Secure Router adopts this task authenticating and encrypting the KNX IP telegrams.

Smart home functions: Using simple voice commands, light scenes can be activated in combination with the required temperature and music. By

conducting a dialogue with the assistant, you can find out the value of the room temperature or the status of the blinds. Voice announcements can be automatically triggered by events and contain messages with process states from the KNX installation. Alarm signals (e.g. firealarm) are carried out with intelligible words which enables rapid and consistent reactions.

Solar functions: In the course of the energy management, the relevant data of the solar power system and associated network supply are recorded by realKNX. Voice responses inform you about the energy gain: values about status and charging direction of the battery are announced automatically or on request. The data and its evaluation can be clearly visualised with the 'Smart Charts' tool in different graphical variants.

Benefits

Life is made easier in a smart home. The tasks can be resolved in an ideal way through the combination of the KNX home automation with the speech information system realKNX. The configuration of the system with the ETS software is possible without any additional specialist knowledge about the integrated functions. The system is also open to the further connection of IoT components as well as directly via Cloud services or IoT client servers.

KNX Secure components

- KNX IP Secure Router, Enertex

Further KNX components

- realKNX system from ProKNX
- KNX smoke detector Salva, Elsner Elektronik
- KNX room control device Cala, Elsner Elektronik
- RGB LED with integrated KNX actuator, Arcus EDS
- Tunable white LED with integrated KNX actuator, Arcus EDS



ProKNX SAS
Christian Kiefel
7 rue Soutrane
06560 Valbonne
France
christian@proknx.com
www.proknx.com

Modern smart home with voice control – announced energy data remains inaccessible to unauthorised persons thanks to KNX IP Secure.

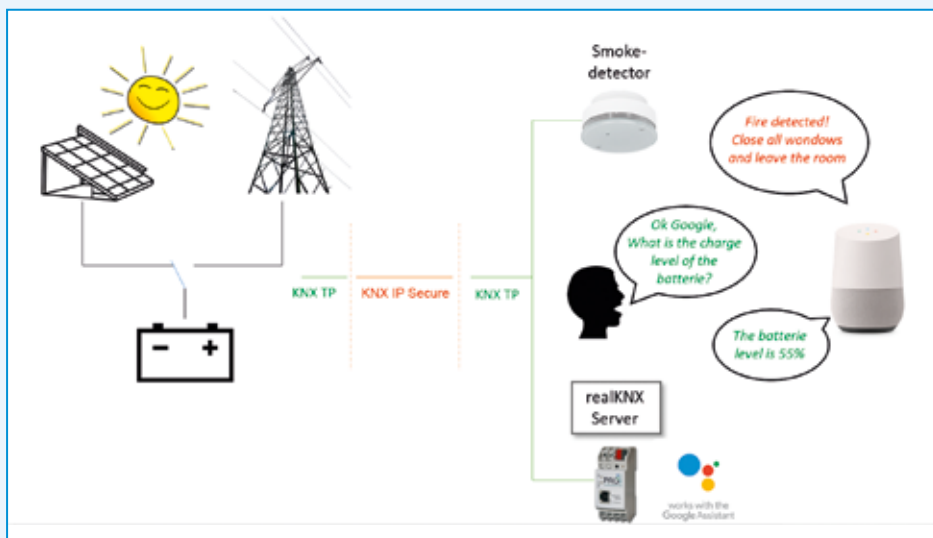

CYBER CRIMINALS HAVE NO CHANCE

Task

Alarm systems ward off intruders. Information technology systems can however also be gateways for cyber criminals. The system integrator Koyn-System-Elektronik had the task of protecting a KNX installation with an integrated alarm system from unwanted access and manipulation of the telegram traffic.

Solution

In the modern smart home, there is a trend towards the integration of the alarm system and KNX installation. It is therefore possible to issue the current operating states of the alarm system to KNX display units and to use the alarm sensor technology for home automation. The KNX alarm system from ABB is available for this purpose. To secure KNX installations against hackers, there are now KNX IP Secure Router available on the market.

Implementation

To illustrate the hazardous situation and protective measures, the system consists of two KNX Lines. An alarm system and KNX display unit is installed on one side. The second Line is used for operation and control via a KNX room control device. The KNX IP Secure Routers not only couple both Lines but also simultaneously secure the data traffic via the 'publicly accessible' KNX IP backbone through encryption of the KNX IP telegrams. The 'unthreatened' Lines remain unsecured. The installation integrates a smartphone visualisation using an Android app as well as a modern Google voice control system via an iKNiX controller. An Easy Gateway Connect2Control from Aartesy serves as a remote access and offers a secure "point-to-point encrypted" connection specifically for KNX.

Functions

The KNX alarm system is operated via its own terminal or more recently via an iOS app with a corresponding mobile device. Both the alarm system and other KNX functions can also be addressed via room controllers or voice control. A KNX LED module clearly signals the "set" or "unset" operating state. The states of the sensors of the alarm system such as window contacts, presence detectors etc. can be visually monitored. Sensor values can also be used for building control. Alarms can trigger home automation functions such as switching the lighting, isolating sockets from the mains, opening blinds or even simulating a dog barking as a deterrent via the loudspeaker of the voice assistant.

Benefits

- Highly modern safety standard
- Cost-effective and future-oriented safety measure
- Cost savings through multiple use of alarm sensors
- Alarms activate switching operations and voice messages
- Stationary and mobile monitoring

Convenient voice control

- KNX Secure components
- KNX IP Secure Router, Enertex
- KNX IP Secure Router, ABB

Further KNX components

- KNX alarm system GM/A 8.1, ABB
- KNX room controller, MeTa Premium, Enertex
- KNX LED4 module, Arcus-eds
- Easy Gateway Connect2Control, Aartesy
- USB charging socket, Basalte
- Voice control, iKNiX



KOYNE
SYSTEM ELEKTRONIK

Koyn-System-Elektronik
Intelligentes Wohnen
Duchrother Str. 38
12559 Berlin
Germany
+49 (0)30 47 03 21 82
info@koyn-system-elektronik.de
www.koyn-system-elektronik.de

Integrated KNX alarm system: KNX IP Secure protects the communication between the operating and display units and the KNX automation with voice control and remote connection.

SECURE NETWORKS OF DISTRIBUTED FACILITIES

Task

For efficient building management, it is advisable to combine the technical monitoring of geographically dispersed facilities of residential buildings, factories, commercial or public buildings. Transmission paths outside self-contained buildings and properties can however be exposed to unauthorised access. Safety functions and confidential data are therefore threatened and demand additional protection against hackers. GePro mBH rose to this challenge with a model KNX installation.

Solution

The KNX systems of the individual, dispersed buildings generally communicate via an internet protocol based for example on Ethernet using an unsecure point-to-point connection. Now that KNX IP Secure devices are available, the KNX IP communication can be protected cost-effectively using additional encryption and authentication of telegrams along the entire IP transmission path.

Implementation

To simulate the situation of distributed facilities, KNX IP backbone and control centre, the sample installations are equipped with KNX IP Secure routers from ABB and Enertex. In the buildings, KNX sensors simulate the building functions for temperature, humidity, CO₂ sensors, leakage sensor, dew formation sensor, valve drive and switch actuators.

Various KNX control panels adopt central operating and control tasks buttons and LED displays as well as a KNX alarm and signal panel.

Functions

Room functions, vents, access control and alarm systems can be controlled and operated from a central location. Status signals, faults and alarms are displayed and evaluated centrally via the building control system. Signals can be acknowledged and switching commands can be triggered via central panels.

Benefits

The IP communication between distributed KNX installations can be better secured against malicious tampering with KNX IP Secure. All the IP telegrams which are transferred here on the basis of LAN/Ethernet are authenticated and encrypted.

KNX Secure components

- KNX IP Secure Router, Enertex
- KNX IP Secure Router, ABB

Further KNX components

- KNX signal and alarm panel, GePro
- KNX panel, GePro
- KNX sensor, Arcus Control
- KNX leakage sensor, Elsner
- Dew formation sensor, Insta
- KNX motor valve drive, Jung
- KNX switch actuator, Siemens



GePro - Gesellschaft für Prozeßtechnik mbH
Dipl.-Ing. Dirk Müller
Heinrich-Heine-Ring 78
18435 Stralsund
Germany
+49 (0) 3831 39 00 55
info@gepro-mv.de
www.knx-taster.de

The routes between facilities can be far-reaching and dangerous, at least for confidential data. The Ethernet connection with KNX IP Secure protects simply and cost-effectively against unauthorised access.

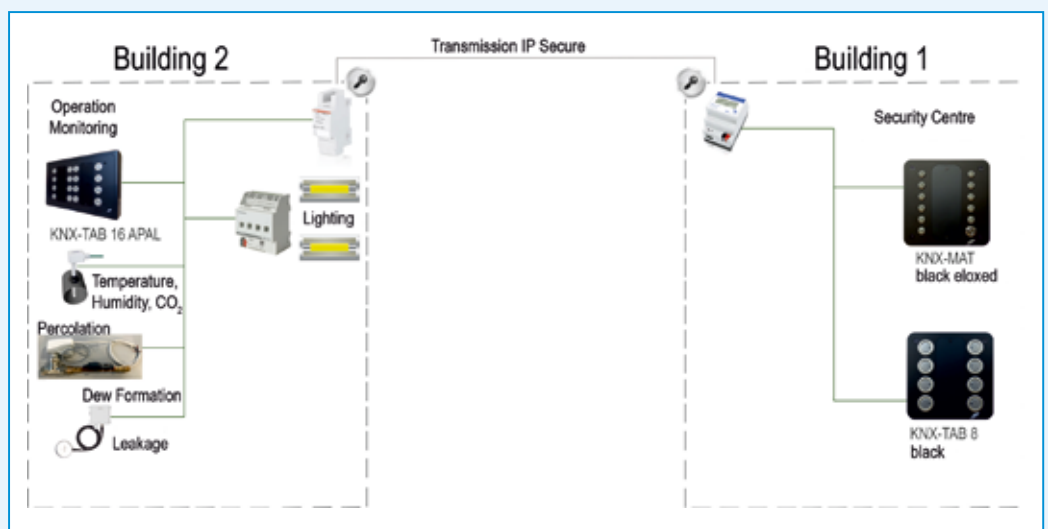

DATA PROTECTION OF DIGITAL ENERGY TRANSITION

Task

More than a third of the energy produced is consumed in residential buildings. The energy efficiency in your home is therefore very important. Digital energy transition within your own four walls is based on KNX and intelligent electricity meters - this is the vision of HSEG, the engineering office for electrical planning and building system technology. The sample installation has the task of controlling the flow of energy in the house dependent on consumption, costs and time. The temporary storage of energy should provide a certain level of independence from energy suppliers.

Solution

Surplus generated energy can be stored in batteries. It would also be feasible to charge electricity from the public network if energy suppliers offer incentives in terms of tariffs. In a similar way as maximum surveillance, it is also possible to regulate energy applications using KNX logic. The use of KNX Secure meets the increased safety requirement of this application.

Implementation

At the core of the installation is an E3/DC solar power storage unit and the KNX Connect interface. The KNX installation illustrates how the IP backbone is protected with KNX IP Secure against access and how all the communication between the terminal devices is secured with KNX Data Secure using authentication and encryption. The IP Secure backbone between two KNX IP Secure Routers links two TP Lines. One is equipped with KNX Secure products such as Line Couplers, push-button interfaces, touch sensors, KNX room temperature controllers and switch actuators. The other conventional TP Line with KNX Connect integrates the E3/DC home

power station with battery. The mixed installation documents the possibility of simultaneous secure and unsecure communication. An IP visualisation panel supplements the system.

Functions

KNX adopts the logical control of energy management, dependent on solar power generation, on tariffs in the public electricity network and on current energy consumption. The KNX logic queries performance and energy values, controls the battery charge or discharge, switches loads, reports faults and can even control an in-vehicle charger. Charging states, battery power, energy consumption and other values can be displayed via a visualisation screen.

Benefits

The battery storage in connection with KNX lowers energy costs, enables flexible energy usage and provides safety against power failures. KNX Secure protects functions and confidential data against hackers and saboteurs.

KNX Secure components

- KNX IP Secure Router, ABB
- KNX IP Secure Router, Enertex
- KNX Data Secure Line/Backbone Coupler, Tapko
- KNX Data Secure 4-gang contact interface, Tapko
- KNX Data Secure glass touch sensor, CONTROLtronic
- KNX Data Secure switch actuator IO 511, Weinzierl

Further KNX components

- Line Coupler, TP, Merten
- KNX Connect, ISE
- KNX smart meter, Enertex
- Touch panel, PEAKnx

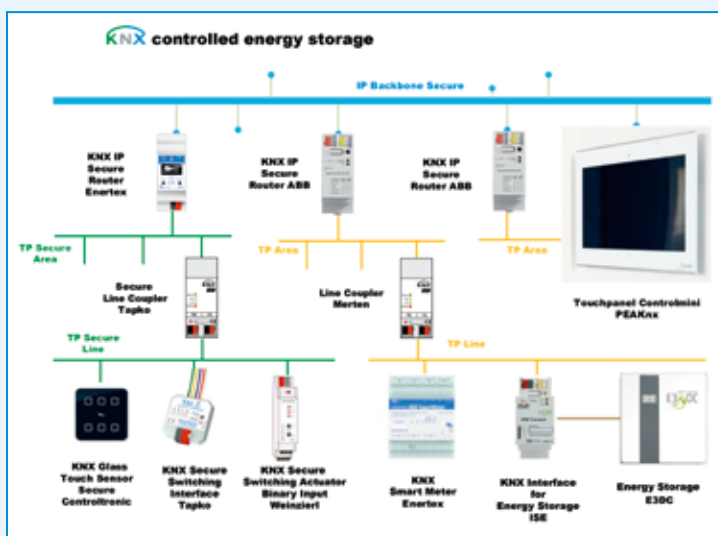

HSEG

HSEG - Ingenieurbüro für Elektroplanung und Gebäudesystemtechnik
 Dipl.-Ing. Holger Schult
 Waidmannsweg 7
 16548 Glienicke
 Germany
 +49 (0)33056 896 32
 info@hseg.eu
 www.hseg.eu

Energy management without snooping: sample installation with new KNX Data Secure routers devices and KNX IP Secure routers protect energy and consumption data against espionage.

SECURE AUTOMATION OF THE HOTEL BUILDING

The “Hotel Solution” panel shows KNX solutions as they are used in high-quality hotels. Based on the usual room functions such as lighting, air-conditioning, sun protection system, music control and operating concepts, it should illustrate the benefits of KNX automation for hotel management, guest comfort and operational reliability.

Solution

The room functions are usually controlled with modular and combinable actuators or DALI gateways. Wireless communication solutions using KNX RF and EnOcean thus prove the flexibility of the system even for safety-related functions. Operation is carried out locally using design switches, remote control or smartphone and centrally via visualisation. The Eisbär Scada software is used for the integration of different subsystems including the hotel booking software Fidelio. To prevent criminals and pranksters from penetrating the network and causing damage, the safety mechanisms of KNX IP Secure and KNX Data Secure are used.

Implementation

In addition to the encryption of WLAN, a KNX IP router with Secure prevents unauthorised access to the KNX IP network. Bus-based KNX components with Data Secure such as the glass push-buttons of CONTROLtronic thwart the identification and notation of individual KNX telegrams by unauthorised persons. Telegrams are thus protected via all the media such as KNX RF, for wireless EnOcean solutions and in contact with subsystems. In addition to the multiroom music system SONOS Play, the DALI RGBW lighting control and a Philips colour lighting controller, Eisbär Scada integrates the safety-related access system EKEY. The blinds can

be controlled wirelessly via KNX RF remote control and TP/RF interface.

Functions

The “Hotel Solution” panel shows how interactions of different KNX protocols and products can be implemented with the benefit of a complete solution for hotels. In addition to the technical and hotel-related functions, the model also demonstrates simple operating concepts with panels, KNX push-buttons, KNX room controllers, KNX RF remote control and tablet PCs or smartphones. Lastly the complete range of safety precautions for IP and KNX systems are displayed.

Benefits

A particular benefit for a hotel is the coupling of the KNX system with the Fidelio hotel booking system via the protected IP network. The associated automation of monitoring, service and room functions considerably reduces the workload for the staff and increases safety.

KNX Secure components

- KNX IP Routers, Tapko, Aprium MECip
- KNX push-button interface, Aprium
- Push-buttons CONTROLtronic, KNX Data Secure

Further KNX components

- Power supply, Tapko
- KNX RF remote control, Elsner
- KNX/DALI gateway, MDT/IPAS
- HUE gateway, MDT
- SONOS gateway, MDT
- Energy meter, Lingg&Janke
- Fingerprint reader, EKEY
- Eisbär touch panel with Scada visualisation



Smart Building Design GmbH
Dipl.-Ing. (FH) Peter Sperlich
Mörsburgstr. 1
8545 Rickenbach-Sulz ZH
Switzerland
+41 76 7500 152
peter.sperlich@highspeed.ch

Untouchable all along the line: KNX Data Secure devices protect KNX telegrams and coupled subsystems are secure.

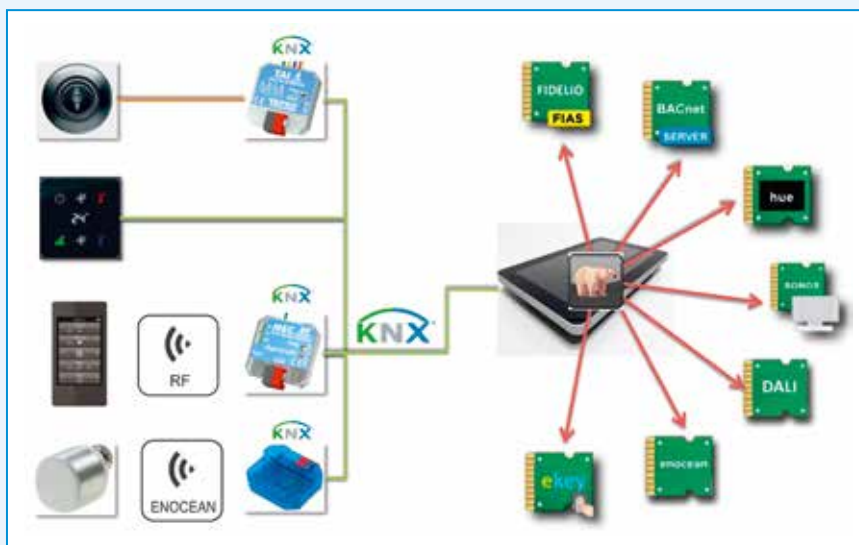

Simple planning and configuration of KNX Secure products

ETS monitors parameters, generates security keys and safeguards projects

Whether it is an office building, industrial facility or a smart home ETS is always a guarantee of an expert KNX installation implemented using compatible products from different manufacturers. Planners, installers and system integrators all over the world rely on this tool for professional automation of building technology. In light of an increase in cyber criminality and a growing need for data security, you can always count on ETS. With continual further development, the software is now also fit for the new security architecture KNX Secure. As a result, ETS users can in future also ensure that their customers have maximum protection against hackers.

The current ETS version 5.6 fully supports KNX Secure. Its main tasks include the project design, parameterisation and commissioning of the devices as well as the project security. Intelligent functions make the configuration of KNX Secure products easy. Once an ETS project has been opened and the topology has been configured, the corresponding KNX Secure products can be imported as usual. They are easy to recognise by a blue “protective shield”.

Monitoring of the status

ETS makes parameters available to carry out device security settings for KNX IP Secure: ‘on’, ‘off’ or ‘automatic’. ETS processes the Group Address security for KNX Data Secure in the same way.

An automatic procedure ensures that devices or Group Addresses which are related to each other always have the same status. If a conventional IP router was inserted for example in a KNX IP Secure medium, it would be rejected by ETS. It behaves in the same way with Group Addresses for KNX Data Secure. ETS indicates if secured and unsecured data points should be linked to a Group Address and suggests solutions for this scenario. A mixed operation is possible if

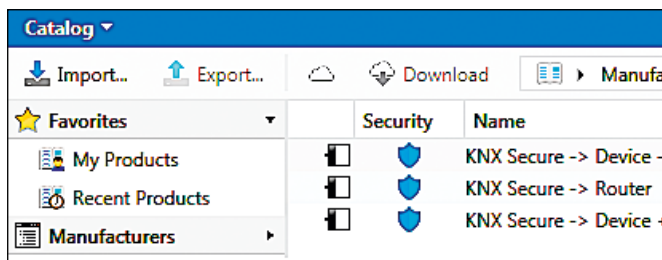

KNX Secure products can be recognised by the Secure icon.

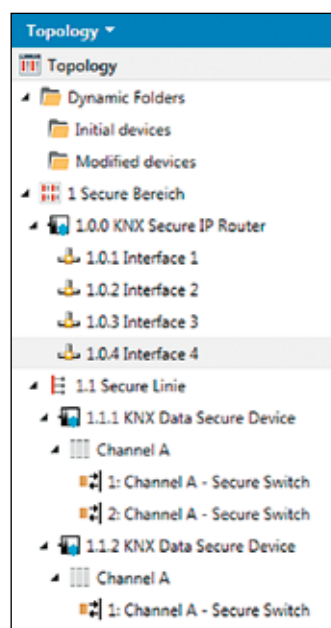

Topology with KNX Secure products



No more digital break-ins!

“Only KNX has been delivering the most appropriate responses”

Highest encryption standards

“Relying on security algorithms standardised according to ISO 18033-3, such as AES 128 CCM encryption”

Double protection concept for twice the security

“KNX IP and Data Secure can be combined and used in parallel to achieve maximum security”

KNX as secure as online banking

“KNX Secure is using the same security mechanisms as your bank, making KNX most trustworthy”

secure and unsecure functions are kept separate. For example, with multiple channel actuators, the Group Addresses of the channel functions can be set as 'secure' and 'unsecure' but then the device itself is 'secure'.

Certification of devices

When the device security and Group Address security is activated, a password must of course be set for the project. This protects the program against unauthorised access. It must also be possible to authenticate each device in the telegram traffic. ETS thus requires an individual device certificate for each KNX Secure product as well as KNX IP Secure and KNX Data Secure. This consists of a device-specific factory key and a serial number. The factory key is located either on the device or is available for example as a code. It can be entered during the project design or at the latest at the commissioning stage if ETS requests it automatically.

The factory key is not sent via the bus but entered externally in ETS or scanned for security reasons. After the initial registration, the ETS automatically generates a new device key which is valid immediately. The original factory key is archived. It can only be activated by resetting the device. A safety principle is thus applied which corresponds to the handling of a home router or the written registration of online banking access.

Management of the security keys

The management of the security key is an integral part of the ETS functionality. During the parameterisation of the project, ETS generates as many runtime keys as required for the group communication that is being protected. The runtime key is stored and can be exported for other applications, for example for visualisation. Finally, all the security keys are stored in the ETS project. They are required for the commissioning phase. They are the last resort if a project is lost as a KNX project cannot be reconstructed without a security key. This process therefore requires reliable archiving of the project software. The list of security keys should be printed out just in case and kept somewhere safe.

For more information about KNX Secure visit: <https://KNXsecure.knx.org>

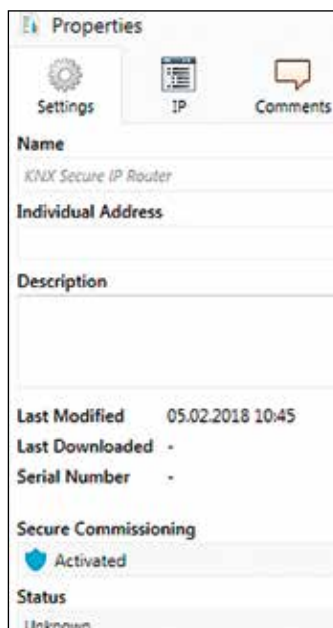

KNX Secure product - Secure commissioning activated / deactivated



When KNX security is activated, ETS requests the factory key.



For secure archiving, ETS makes documents available with all the device keys.

New KNX Secure Products

KNX Association is proud to present the first KNX IP Secure and KNX Data Secure products. With devices coming from various manufacturers, KNX Secure is ushering the new era of security for smart homes and smart buildings all over the world.

For further information about KNX Secure, please visit: <http://KNXsecure.knx.org>

ABB i-bus® KNX IP Secure – IPR/S 3.5.1

ABB Nowadays security is one of the key decision factors when it comes to smarter buildings. ABB's IP Secure products protect the KNX installation and offer the highest security which is available on the building automation market. KNX telegrams are now transmitted in encrypted form between KNX IP routers on the IP network. Runtime communication on IP as well as commissioning via ETS is secure now, ensuring that KNX telegrams cannot be read on IP.

Contact: www.new.abb.com



GT – Glas Touch Sensor

CONTROLTRONIC GMBH KNX Glass Touch Sensor and KNX Room Thermostat with KNX Data Secure: The CONTROLtronic glass touch series Living Emotions® offers innovative technology and superior design: Real glass in different colors and finishes, Icons self-exchangeable for one to seven sensor fields, Color LED illumination RGBW, Proximity detection, Temperature and air humidity sensor and Flat in-wall mounting with invisible magnetic fixing. With the support of KNX Data Secure, the CONTROLtronic KNX Glass Touch Sensors and KNX Room Thermostats make it possible to set up a secure and protected KNX installation. In commercial buildings, hotels and in outside and public areas of residential buildings – so wherever the KNX Line is free accessible – protection of the installation by data encryption is essential.

Contact: www.controltronic.com

IO16F01KNX

ELECTRON The IO16F01KNX has 16 inputs/16 outputs, 16a rated module for lights, fan coils, venetians and valve controls. It controls up to four analogue inputs, has manual control and an SD card to save ETS configuration for fast recovery. The product supports KNX Data Secure, allowing ETS security activation over Group Addresses with data protection password. The device allows: device authentication, where sender MAC address is decrypted and authenticated to avoid fraudulent message replication; message confidentiality, where message content is encrypted and decrypted from authorised receivers; or both.

Contact: www.eelectron.com



Enerutex KNX IP Secure Interface

ENERUTEX The KNX IP Secure Interface (2TE) authenticates and encrypts KNX and IP telegrams. Up to eight tunnel connections can be used encrypted or unencrypted. The communication performance is impressive with up to 49 telegrams per second. The interface has a buffered real-time clock and SNTP server. An OLED display shows important device parameters. Telnet provides further parameterization and diagnostics functions. The interface is powered directly from the KNX bus.

Contact: www.enerutex.de



Enerutex KNX IP Secure Router

ENERUTEX The KNX IP Secure Router (2TE) authenticates and encrypts KNX and IP telegrams. Up to eight tunnel connections can be used encrypted or unencrypted. The communication performance is impressive with up to 49 telegrams per second. The device can be used as a line or area couple. The router has a buffered real-time clock and SNTP server. An OLED display shows important device parameters. Telnet provides further parameterization and diagnostics functions. The router is powered directly from the KNX bus.

Contact: www.enerutex.de

Gira KNX IP-Router Secure

GIRA GIERSIEPEN GMBH & CO. KG The Gira KNX IP-Router connects KNX Lines via IP networks with the function of a Line/Area coupler and serves as ETS data interface. Next to the many benefits of an IP infrastructure, it also offers of course an obvious threat of being tampered with. Thanks to the support of KNX Secure for protected communication, the Gira KNX IP Router is the first choice to counter this kind of attacks. Smart additional functions, such as a KNX timer or the KNX telegram recording on microSD card, top the device off.

Contact: www.gira.de



RNX-GW1



REDFISH The RNX-GW1 is a modern security focused interface between the KNX network and the rest of the world. At its core, it supports the KNXnet/IP Secure protocol, with up to 25 concurrent tunnelling connections. Secure end-to-end remote access (including programming with the ETS) is included with the KNX Anywhere cloud service. Also included: web ready (management app, web services), configured for guaranteed automatic security updates, multi-user support with roles, google home integration, modbus, ...

Contact: www.redfish.com.au/edge

KAlstack-secure

TAPKO Due to growing demand for secure communication, TAPKO is offering full KNX Secure support in its latest KNX communication software release, KAlstack-secure. In spite of increased complexity, the application developer has almost no additional effort despite KNX Secure. Updating existing KAlstacks and applications is straightforward. The required update ability is satisfied with a sophisticated robust remote update process for reprogramming the complete firmware - KAlstack-secure together with application. Since KNX Secure has also hardware impacts, new hardware EVAL boards are offered for evaluation.

Contact: www.tapko.com



MECtp-secure

TAPKO presents the Line/Area Coupler MECtp-secure as first system component supporting KNX Secure. Its ability to process secured telegrams guarantees safe commissioning. Being particularly important for Couplers and Routers, the configuration communication is protected. To prevent access to the Main Line, MECtp-secure can block device-oriented messages from the secondary Line. The function button, originally introduced by TAPKO for temporary deactivation of message filtering, is further improving the comfort and reliability of this device.

Contact: www.tapko.com

TAI4-secure

TAPKO TAPKO's proven TAI4-secure 4-fold binary I/O module is now available with KNX Secure. Any kind of manipulation during runtime communication and commissioning is not possible anymore. All usual input functions of the I/O module like switching, dimming, shutters, blinds control and scenes can be used in a common way. Besides the input functionality of TAI4-secure for sensing NO/NC floating contacts of push-buttons, conventional switches and contact sensors, it is also a perfect binary output for driving various loads, like status LEDs, with a comparably high amount of power. Even dimming of the connected LEDs is possible. Due to its small housing, TAI4-secure finds place in a flush-mounted box behind the switch.

Contact: www.tapko.com



UIMip-secure

TAPKO In times of hackers intrude in building technology, UIMip-secure, the security enhanced version of our existing UIMip, is the proper answer. While KNX Secure is a red-hot subject, UIMip-secure connects the ETS for commissioning and monitoring in a reliable and secure way over IP. UIMip-secure protects the tunnelling protocol successfully against intrusion, according to the standard EN 50090-4-3. UIMip-secure is preserving valuable features like no external power supply, device info and firmware update via web frontend. Also available as OEM.

Contact: www.tapko.com

MECip-secure

TAPKO MECip-secure is the security enhanced version of our existing high performance KNXnet IP Router, connecting the upper KNXnet IP Line and the lower KNX TP Line. MECip-secure protects successfully against intrusion attempts, according to the standard EN 50090-4-3. Of course, valuable features like: no external power supply, reduction of unnecessary traffic in case of misconfiguration, manual suspending of filtering, device access and firmware update via web frontend are preserved. The integrated tunnelling protocol connecting ETS for commissioning and monitoring is also secured.

Contact: www.tapko.com



IPS640-secure

TAPKO IPS640-secure, the security enhanced version of our existing intelligent KNX Power Supply. IPS640-secure is fully protected against hacker attacks, according to the standard EN 50090-4-3. This way crucial functions like KNX bus reset of a Line, sending of alarm messages like: internal temperature, overload, short-circuit, device start-up and measurement alarms (after threshold value crossing) are protected against misuse. IPS640-secure is the slimmest intelligent 640 mA KNX Power Supply on the market at only 2 TE (35 mm). It is minimising costs as more KNX devices can be mounted on a single DIN-rail. Also available as OEM.

Contact: www.tapko.com



KNX IO 511 (Secure)

WEINZIERL ENGINEERING With the KNX IO 511 Secure, Weinzierl has expanded its product range of the IO product family with a device with support for KNX Data Secure. The compact switch actuator with one bi-stable output and two binary inputs provides functions for universal outputs including scene control, on / off delay, staircase light switching and control of heating valves. The inputs can be connected to conventional switches with an external voltage of 12 to 230 V. The actuator combined with input B1 serves as a latching relay. Input B2 is used for zero crossing detection. The configuration is encrypted with the ETS5.

Contact: www.weinzierl.de



KNX RF Push Button Insert 440

WEINZIERL ENGINEERING The KNX RF Push Button Insert 440 by Weinzierl is compatible with standard switch housings and is characterised by a soft pressure point of the buttons. It is suitable as an alternative for wired switches without routing bus cables. The device is commissioned with the ETS5 and supports KNX Data Secure. The push button is freely configurable as single or double rockers for switching, dimming and blind functions. In addition, values can be sent and scenes can be called up. The connection to KNX TP is made via a KNX TP/RF Coupler (e. g. new Weinzierl KNX TP/RF 672). An integrated USB interface is used both to configure the device and to program other KNX RF devices. It is powered by a standard CR2032 battery.

Contact: www.weinzierl.de





New ETS Apps



You can find all ETS Apps at <https://my.knx.org> ▶ Shop ▶ ETS Apps

ABB Update Copy Convert



ABB STOTZ-KONTAKT GMBH This app provides a series of useful functions for device configuration (parameters and Group Addresses) in an ETS project. The functions are:

Update: Changes the Application Program to a later or earlier version while retaining current configurations.

Convert: Transfers/adopts a configuration from an identical or compatible source device.

Channel Copy: Copies a channel configuration to other channels on a multichannel device.

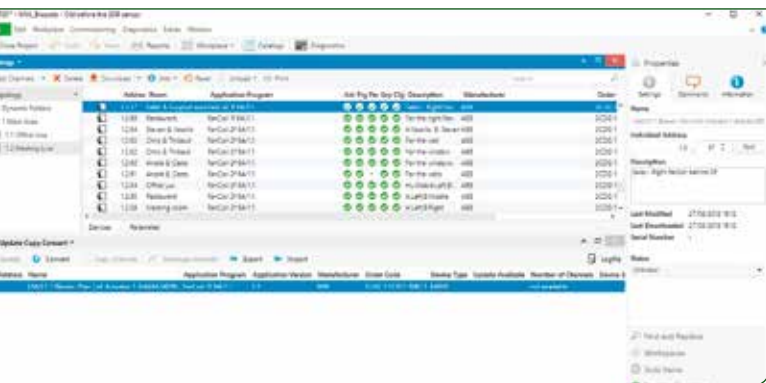
Channel Exchange: Exchanges configurations between two channels on a multichannel device.

Import/Export: Saves and reads device configurations as external files.

Contact: www.abb.com

Additional tool Excel-Converter

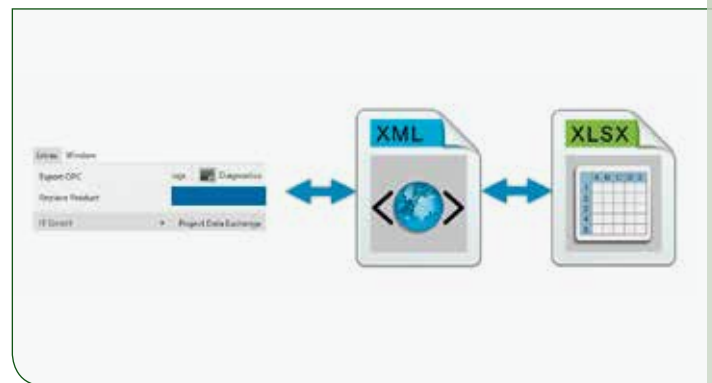

IT GMBH The tool is available to all licensees of the ETS App project data exchange free of charge. The well-documented XML format for project data exchange enables uncomplicated, bidirectional integration of external tools, such as CAD programs or databases. The Excel Converter converts this XML format into an Excel format. This conversion is based on an attached, changeable template with which the desired output format is defined.

Contact: www.it-gmbh.de.

ETS App Project Comparison

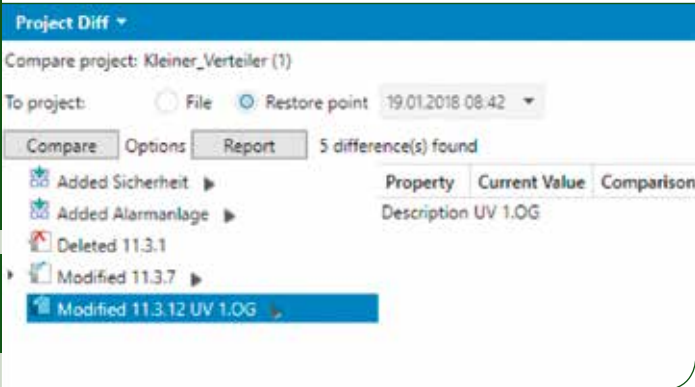

IT GMBH Get an overview through a targeted comparison of your current project with other projects or with different project statuses of the same project. The differences are determined on the basis of knxproj files of ETS 5.5 or higher.

The result of a comparison lists all newly added, deleted and changed elements. From the list you can jump directly to the changed element. For the documentation, the result can be printed or saved as a PDF file. *Contact: www.it-gmbh.de.*

eConfigure KNX Expert

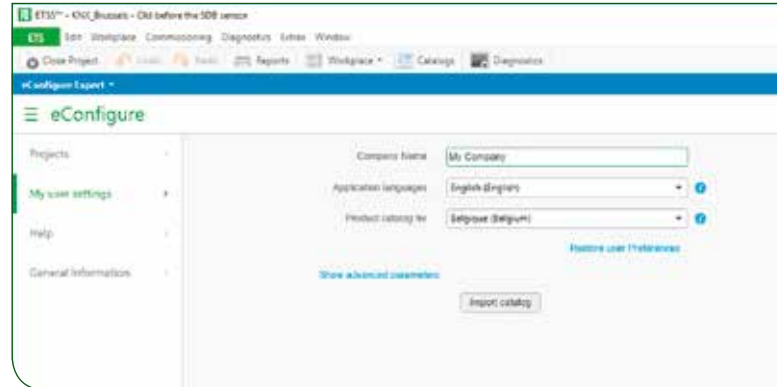

SCHNEIDER ELECTRIC INDUSTRIES S.A. “eConfigure KNX” by Schneider Electric is a graphical configuration ETS app for KNX projects. This tool is adapted for residential projects and small/medium building projects. You can design the complete KNX project using drag-and-drop sensors and loads according to the floor plan of the building and then connect them easily. The actuators are automatically generated and linked to loads on each floor of the building. “eConfigure KNX” is supported in Germany, France, Italy, Denmark, Sweden, Finland, Russia, Belgium, Chile and Portugal.

Contact: www.schneider-electric.com

Project Management ETS App

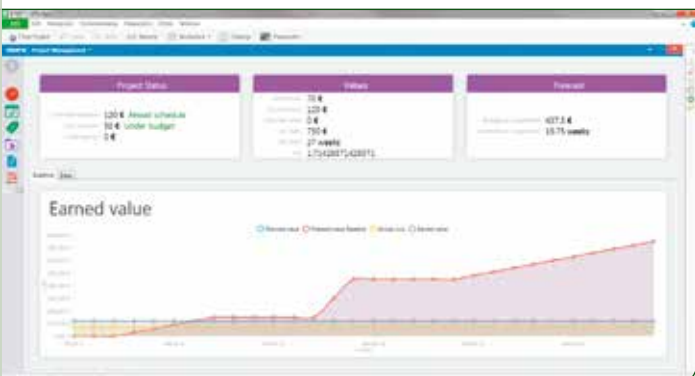

SUDOKU INNOVATION If you are among the KNX Partners that live and breathe KNX, if you keep bus connectors in your pocket, if your laptop is covered by a layer of construction dust... this is the App for you. Designed for the best performance, this is the ETS app for full project management. Software features? Set your tasks, log your work, supervise all the equipment and installation material, follow up with project costs, apply the earned value and track the critical path... all conveniently shown on the dashboard. Visit our website and get a free guide of applied project management in KNX (normally priced at € 39). KNXPM ETS app designed by a PMP, available in English, Spanish, German and Swedish.

Contact: www.knxpm.com



New Members

ABEGO S.C.



POLAND ABEGO is an innovative start-up company of new technologies, created to provide smart home solutions, especially according to the KNX Standard. Its activities are focused on the development of three types of devices. The most important are wall switches. A second area is gateways between the KNX system and other home automation standards. The third type of device is a wide range of specific executive devices. Aesthetic design and new functionalities are the most important goals for ABEGO. There are two crucial elements which guarantee the design success of ABEGO products – over 20 years of home and building installation experience and electronics assembly and design provided by the company's founders.

Contact: www.abego-elektronik.com

Advanced Devices Limited

Advanced Devices

CHINA Advanced Devices Co. Ltd is a foreign-funded, high-tech enterprise engaged in intelligent automation control, bringing innovative technologies and solutions to China and Asia. With an outstanding engineering team proficient in software, hardware and product design, Advanced Devices is focused on building automation and intelligent home solutions, such as lighting control and temperature control. All nodes in the system are wireless, battery-less devices, which gives flexibility and simplicity at the construction stage.

Contact: www.advanceddevices.com

Artman Smart Energy Solutions



IRAN, ISLAMIC REPUBLIC OF Artman Dev. is a branch of Artman Smart energy Solutions focusing on KNX Devices and Apps developing. Their first core of R&D was founded in 2011 consisting of Electronics, IT, Computer and Smart Grid experts. Artman started its activity as a Smart home and BMS solutions provider. The company will develop KNX devices for special purposes and global solutions. Artman will also introduce new ETS apps for professionals. As an active KNX integrator, they started official connections with KNX from Iran and after successful events, they became first Iranian KNX training center. The company focus is on Smart Home, Smart Buildings and in the future Smart Grid integrating renewable energies.

Contact: www.smart-buildings.ir

Automatismi Beninca spa



ITALY Automatismi Benincà is a part of the Benincà Group that has been designing and marketing door and gate automation systems for over thirty years. The company is a point of reference on the international scene, distributing its automation systems for industrial and residential use all over the world. Today, the group is made up of five companies (BENINCA', CAB, HI MOTIONS, RISE, BYOU and MYONE) each specialized in the building automation sector. It has a cutting-edge research and development department designing products and systems to improve the mobility of things and people. Through a profitable synergy between the different brands, the group is able to provide highly specialised products, such as to anticipate market demands and able to solve complex problems.

Contact: www.beninca.com

Eliq AB



SWEDEN Eliq is a Swedish tech company specialised in the analysis and visualisation of energy data. Their aim is two-fold: to reduce energy waste by helping households understand their consumption, and through this, assist energy suppliers engage with their customers with real-time information and personalised communications. Using their software, and a device which connects to the home's smart electricity meter, utilities are able to help their customers track there in home energy usage in real-time, and better manage their consumption. Eliq's Head Office is located in Sweden with offices in the UK and France.

Contact: www.eliq.io

Faradite Ltd



UNITED KINGDOM Founded in 2016, Faradite Ltd specialises in smart home accessories with a signature range of contemporary capacitive smart switch plates. Based in the UK, their products are sensibly priced without compromising on design, quality or customer service. Their TAP-5 and TAP-1 switch plate ranges feature haptic vibration feedback giving a unique user experience, and the TAP range can be customised to suit bespoke user requirements. Faradite Ltd offers a new option for effortless smart home control.

Contact: www.faradite.com

frogblue AG



GERMANY frogblue is a dynamic start-up based in Munich and Kaiserslautern. Leading-edge knowledge, business experience and solid financing are the pillars of their innovation-based company culture. The focus lies on the development and sale of revolutionary simple systems for the rapidly growing smart home and building appliances market.

Contact: www.frogblue.com

German Moorgen Intelligent Technology Co., Ltd



CHINA Moorgen is a leading global manufacturer of smart home systems. Its main product range covers smart home systems, control systems and relevant accessories. Their products have been verified by various international safety authorities and are thus able to satisfy the most strict safety requirements in the global market. In their plant, they have adopted an ERP system to manage the lead time and ensure the on-line delivery rate. The company's home automation system has truly realised an intelligent and remote control of home appliances from anywhere, whenever you like.

Contact: www.moorgen.de

Glamox AS



NORWAY Glamox is a Norwegian industrial group that develops, manufactures and distributes professional lighting solutions for the global market. The Glamox Group is a leading supplier to the world's marine and offshore markets and a significant supplier to the professional building market in Europe. The Glamox Group is a global organisation, with 1300 employees and sales and production in several European countries, as well as in Asia and North America. The annual turnover is MNOK 2.500 (2016). The group owns a range of quality lighting brands including Glamox, Aqua Signal, Luxo, Høvik Lys, Norselight and LINK-Srechts. Glamox is committed to meeting customer needs and expectations by providing quality products and solutions, service and support.

Contact: www.glamox.com

Guangdong Daming Laffey electric Co., Ltd,

Laffey Electric
中国高端酒店别墅开关领军品牌

CHINA Guangdong Laffey Electric Co. Ltd is an electric products manufacturer including research and development, production, sales and service. Knowing KNX is the worldwide standard for home and building control, they decided to join the KNX Association to develop KNX products and ETS apps. They plan to become a manufacturer of KNX devices and applications such as lighting control, shutter control, heating, ventilation, air conditioning, background music, etc. and share their products with customers all over the world.

Contact: www.laffey.com.cn

Guangzhou Letour Life Technology Co., Ltd.

LETOUR
乐原生活科技

CHINA Guangzhou Letour Life Technology Co. Ltd is located in Panyu Energy Saving Technology Park, Guangzhou, Guangdong Province, China. The core of its technical team consists of the technical elite of Fortune 500 companies such as Huawei and Panasonic. The company focuses on smart electronics, smart homes and buildings. The company plans to embed small KNX wireless modules (switches, dimmers, curtains), intelligent gateways, intelligent configuration software, voice panels and other products. The company is committed to providing customers with smart products.

Contact: www.dynamaxcn.com

Hangzhou EaseMore Technology Co., Ltd.

EaseMore 芝墨

CHINA Established in 2017, Hangzhou EaseMore Technology Co., Ltd. is a professional manufacturer and exporter that is concerned with the design, development and production of KNX. They are located in HangZhou, with convenient transportation access. All of their products comply with international quality standards and are greatly appreciated in a variety of different markets throughout the world. They are looking forward to forming successful business relationships with new clients around the world in the near future.

Contact: www.easemore.cn

Hisense Smart Home



CHINA Qingdao Hisense smart home system Ltd is affiliated with the Hisense group. They are very innovative in their main processes, which cover smart home system solutions, R&D, design, sales and installation, as well as service. As a KNX Member, they will provide smart home and building hardware and software products and services based on Hisense Cloud and their own app.

Contact: www.hisensesmarthome.com

Ilevia srl



ITALY ilevia is an Italian company established in 2006 as the Home & Building Automation division of a leading electrical installation company in the North-East of Italy. Since the foundation, they have formed strong relationships with many companies in order to develop innovative smart home/smart building solutions. Today, ilevia counts on international distributors and partners, all sharing a common vision and dedication to innovation. With expert knowledge in IT security systems, the company is a certified Mikrotik Partner that gives users maximum security for data transmission and storage on the net. ilevia is also a KNX Partner and one of the first Microsoft Azure Internet of Things Partners.

Contact: www.ilevia.com

KOPLAT Llc



BULGARIA The KOPLAT company focuses on the development and production of PLCs of the appropriate ideologies of both the third generation (decentralised architecture) and the fourth generation (multi-interface, hardware-independent, application development language). They plan a cardinal expansion of the functionality of typical devices used in the field of building automation and home automation.

Contact: www.koplat.com

Liaoning Systemteq Information Technology Co.,Ltd



CHINA Liaoning Systemteq Information Technology Co. Ltd was founded in 2014. The main business includes smart home and IoT engineering technology research and development. They focus on network information and software technology development, technical services and other operations management services.

Contact: www.systemteq.net

Lynxus Technology Corp.



UNITED STATES Established in 2012, Lynxus is a lighting solutions manufacturer focused on advanced lighting control systems within the Internet of Things (IoT). Their diverse technical skill set along with 30 years of experience in the lighting industry offers a unique perspective on the manufacturing needs and market requirements. Lynxus provides solutions and integration methods for specialty lighting needs, whether new installations or existing retrofits. As a premier switch-mode power supply company specialising in LED fixtures, Lynxus has a unique view of the market. We deliver distinctive lighting systems that enhance environments and leave lasting impressions. *Contact: www.lynxus.com*

Merck Window Technologies B.V.



NETHERLANDS Merck Window Technologies B.V. is the developer of Liquid Crystal Windows, an innovative switchable glazing. LCW puts you in control of the light in your building. LCW solar glazing switches from dark to clear at the flick of a switch. A range of colours and shading can be adjusted to your requirements. Our new LCW privacy glazing switches from opaque to clear instantaneously. LCW glazing can be used for interior and exterior applications for facades or windows.

Contact: www.merckgroup.com

Mindjaga Ltd



Mindjaga Ltd
Next Generation
Products & Services

UNITED KINGDOM Mindjaga Ltd designs and updates products and services for itself and its customers. We endeavour to include intellectual property elements in our designs to add value for their customers. The services for commercial customers include software that helps automate their processes. With reference to KNX, they are involved particularly in building automation and monitoring. The aim of automation and monitoring is to help ensure that building systems are working as they should and with the benefit of a reduction in maintenance costs and energy use.

Contact: www.mindjaga.com

Ontrol



TURKEY Ontrol is a major system integrator in Turkey and Eastern Europe that designs and manufactures controllers, sensors, valves and actuators to their own demanding specifications. All products come from 50 years of experience as installers and reflect their experience and understanding of what is needed on-site under demanding conditions. Ontrol traces its roots back to 1963, when the Özköseoğlu Company was founded. The company developed a strong specialization in automatic control systems, representing world leaders such as Honeywell and Belimo, through several decades. The expertise expanded from fully pneumatic systems to state-of-the-art building management systems of the day. Today, Ontrol continues to be an intensively focused controls company under second-generation management.

Contact: www.ontrol.com

Pharos Architectural Controls Ltd.



UNITED KINGDOM Pharos Architectural Controls provides advanced lighting control solutions for architecture, themed entertainment and other specialist industries. Their award-winning products are installed across the world, running day and night in international landmarks, theme parks, shopping centres, stadiums, art installations, museums and airports. Since 2004, the Pharos team has been privileged to work with outstanding designers, architects and installers, producing solutions and support for complex lighting, art and multimedia installations. The company's approach has been validated by significant annual sales growth and an increasing number of partnerships with many key lighting manufacturers and dedicated project specialists. All Pharos equipment is designed, engineered and manufactured in the United Kingdom, allowing for complete control over the quality of each and every item.

Contact: www.pharoscontrols.com

Robot S.A.



SPAIN Since 1983, Robot SA has been designing, manufacturing and installing smart systems for the control of the technical installations of hotels and buildings (BMS and GRMS). In Palma de Mallorca, they have their headquarters spanning 1500 m², where their manufacturing facilities, their department of works and their own R+D+I department are located. Their team is made up of highly qualified personnel in each facet of their activity and they use state-of-the-art machinery for the production of their equipment and for carrying out our tasks. They are focused on quality and the environment, which is why they have ISO 9001 and 14001 certifications. Their goal is to satisfy the needs of their clients, adapting quickly to their new demands. **Contact:** www.robotmallorca.com

Sensorite Controls Sdn. Bhd.



MALAYSIA Flink System is an integrated automation system provider who delivers total design solutions for smart home, Building IoT (BIoT) and Industrial IoT (IIoT) applications. They deliver innovative solutions to increase property value, enhance safety and security, create cozy indoor environment quality, improve energy and maintenance efficiency and lower the property operating costs towards living experience and building sustainability. Their business scope includes consultation, system design and integration, system software development, data analytics and ongoing optimisation. **Contact:** www.flinksystem.com

Shenzhen Michoi Security Technology Co., Ltd.



CHINA Shenzhen Michoi Security Technology Co., Ltd. is a high-tech enterprise. The company focuses on long-term visual intercom and smart homes, product development, production, sales and service in one. They are a professional manufacturer of reliable visual intercom and intelligent home products. Since its foundation, Michoi has always insisted on independent research and development and technological innovation. The company gained many national invention patents, utility models within appearance design patents, software copyright patents etc. and has been approved by several international and domestic authoritative attestations. **Contact:** www.michoi.com

Voxior Inc.



SLOVENIA Voxior connects KNX with various smart home assistants (Amazon Alexa, Google Assistant, Apple Siri, ...) and integrates IoT devices natively to KNX making smart homes even smarter. They started with bringing the Voice interface to KNX without any additional hardware needed - a seamless setup without any programming changes on the Smart Home server accompanied by continuous updates of new features and 24/7 support in multiple languages. With Amazon Alexa and Google Assistant already onboard, and Apple Siri launching soon, they are now working on solutions beyond voice control. Voxior is taking IoT integrations in Premium Smart Homes to the next level. Users will soon be able to effortlessly integrate IoT devices as if they were connected to the bus. **Contact:** www.voxior.co

Westerstrand Urfabrik AB



SWEDEN Westerstrand Urfabrik AB markets and produces modern time systems and information boards for use in public environments such as hospitals, schools, industry, retail and sport arenas. More than 60 % of their deliveries are to foreign customers. The company, with about 70 co-workers, is privately owned and located in Töreboda, Sweden. Offices are also located in Stockholm and Örebro. Affiliated companies are located in Belgium and France.

Contact: www.westerstrand.se

Wuhan RuiLi Smart Control Technology Co.,Ltd.



CHINA Wuhan RuiLi Smart Control Technology Co. Ltd is a high-tech enterprise, specialising in intelligent home and building control systems, product development, production and marketing. The company has an R&D team with many years of experience in KNX. RuiLi is innovative, competitive, market-oriented, committed to providing customers with professional, personalised products. RuiLi's products are sold to domestic and foreign high-class hotels, large public venues, commercial buildings, villas, homes, etc., and meet the customer's unanimous approval and praise. RuiLi's team will continue to support with rapid response and positive, flexible market adaptability to meet customer needs in different regions, providing customers with quality products and services.

Contact: www.zmlqoes.com

xxter BV



NETHERLANDS xxter is situated in Amsterdam and is a manufacturer of visualisation, integration and control solutions for KNX and others. For visualisation, xxter provides apps for iOS, Android and PC, which are easy to set up for the end user. The user can also set up scenarios, schedulers and presence simulation directly in the app. Their new product, the Pairo, provides voice control with HomeKit and Alexa for the KNX installation. The company has been active for over ten years and works with an in-house development and engineering team, which allows high flexibility and quick turnaround times to continuously create new features for their customers.

Contact: www.xxter.com

Zhuhai Noblesse Technology Co.,Ltd.



CHINA Zhuhai Noblesse Technology Co.,Ltd. from China has delved into the study of "Smart System" and carried out indepth research in different countries according to market trends. They manufacture products for intelligent lighting control, Smart Hotel rooms and other fields of intelligent home control and are used in all types of buildings. Total customer satisfaction is their ultimate goal.

Contact: www.knxnobls.com

New Products

New Blind and Roller Shutter Actuator with Binary Inputs



ABB The new blind and roller shutter actuator with binary inputs JRA/S 6.230.3.1 allows the safe and easy operation of six independent blinds, shutters, lights or any other loads of up to 6A and is equipped with 12 binary inputs allowing the installer to choose between KNX sensors or any other standard push buttons. In delivery condition the actuator is preconfigured for shutter operation. The inputs are internally connected to the respective outputs so that the device can be taken in operation directly after connecting the bus voltage.

Contact: www.abb.com/knx

Line Coupler with KNX Secure

APRICUM D.O.O. presents its first system component Line/Area Coupler MECTp-secure supporting KNX Secure. Its ability to process secured telegrams guarantees safe commissioning. Being particularly important for Couplers and Routers, the configuration communication is protected. To prevent access to the Main Line, MECTp-secure can block device-oriented messages from the secondary Line. The function button originally introduced by Apricum and TAPKO for temporary deactivation of message filtering is further improving the comfort and reliability of this device.

Contact: www.apricum.com



INSPINIA

ASTRUM TECHNOLOGY INSPINIA is an all-in-one device for your home and building automation needs. Combines home server, touch panel, intercom and security. New dual add-on module system and various add-on modules let integrators choose their desired connectivity and control options which gives flexibility and exact needs in one solution. Some of the add-on modules are KNX, RS232, RS485, VRV/VRF. Allows end users to create their own scenarios on panels and full control including intercom communication via a mobile app. It has 7" and 10" display and outlook design options. Stunning outlook and stability promises the best value.

Contact: www.astrum.com.tr



Occupancy sensor PICO-KNX

B.E.G. BRÜCK ELECTRONIC GMBH The world's smallest KNX occupancy detector: In presenting the new PICO-KNX occupancy detector, B.E.G sets standards: with dimensions of only 33 x 34 mm (height), it is the world's smallest KNX occupancy detector. It adapts to almost any mounting requirements and can easily be integrated into luminaires. Despite its small size, the detector has an impressive detection area of 10 m (diameter) at a mounting height of 2.5 m and approx. 12 m at a mounting height of 3 m. The detector PICO-KNX offers almost all the functions of the B.E.G. KNX Generation 6 (DX), e. g. the short presence with shortened follow-up time after short occupancy of the room or the offset function for up to three lighting zones.

Contact: www.beg-luxomat.com



Friends for life



BAB TECHNOLOGIE GMBH CUBEVISION 2 and CUBEVISION COMPANION. The popular KNX and EnOcean visualisation comes with many new features. Scenes can be created directly in the visualisation by drag & drop and linked to conditions. For this purpose, the software offers week timers with astro function, KNX events and manual triggers. These can be combined with AND as well as OR functions (IFTTT+X). The 10 inch hybrid push button "CUBEVISION COMPANION" with its brilliant full HD display, mechanical buttons, and many sensors (luminance, CO₂, radar, temperature and many more) offers all possibilities of a future-oriented control unit for the smart home.

Contact: www.bab-tec.de

New Cubik series

BES – INGENIUM SL launches the new Cubik series: capacitive push buttons and thermostats. Push buttons are available in two sizes and different touch areas: Square 2, 4 or 6 touch areas and Vertical 6 or 8 touch areas. It allows the control of binary outputs, blinds, dimming, fan coils, etc. Internal thermostat and humidity sensor can also be integrated. In addition, thermostats can include a graphical interface. Cubik devices have a glass surface and ultra thin design. Rear can be white or black, but the glass at the front can be: Basic (white or black fixed glass), Design (custom fixed glass) and Capriccio (interchangeable (due to a magnet system) totally customised). This makes Cubik versatile and adaptable to any stay and need.

Contact: www.besknx.com/website/en.



ANY

BLACK NOVA Crafted with marble, metal and glass, ANY's look is avant-garde. It's a revolutionary fusion of artistry and technology. ANY welcomes you with a lambent light emanating from the 841 RGB LED matrix. It shines through the panel's surface, taking the form of a swimming jellyfish, a windy flower, or any possible shape. ANY activates once you get closer, responding to the slightest of hand motions. Each panel has its own set of sensors that check temperature and humidity creating a perfect, personalised habitat. With a fluid swipe to the left or right, ANY takes you to control options such as music, lighting, climate or shading, no matter which room you are in. It's seamless home automation seen as artwork.

Contact: www.blacknova.co



DOORY: Access control for tourist accommodation

BLUMOTIX S.R.L. Blumotix has designed a new capacitive glass keyboard for access control dedicated to bed and breakfasts and hotels, with remote saving to update credentials for each customer. Doory is a smart numerical keyboard that enables you to change access code with your mobile every time you have to welcome a new guest. Doory is a glass touch device with 12 keys, equipped with backlighting activated with a proximity sensor. Internal memory can store up to 100 access codes to manage common areas with all codes already enabled for all single rooms. Each code has six digits to grant additional safety.

Contact: www.blumotix.com



General Actuator



BOSMER announces its new general actuator. GAP series are available in two different versions with 12 and 19 outputs. The main function of the device is switching but for more flexibility the device is designed for various requirements such as shutter control, switch control and heating PWM control. The difference between these two versions is the number of outputs and all these outputs are configurable under dozens of combinations. The device is only 9MW on DIN-rail at distribution board. With the GAP device, Bosmer presents competitive price and good quality.

Contact: www.bosmer.com

BSmart KNX Multi Module BSM24-16A-01

BSMART The BSmart multi actuator is a KNX-certified device available with 8, 16 and 24 channels. Modules are supplied over KNX bus and do not need any other external power supply. The communication of the devices via the KNX bus enables information exchanges with KNX sensors and the integration with a building management system. Outputs of the multi module can be configured to different functionalities depending on the project needs and therefore support many combinations. The configuration of the device is performed via ETS4 or higher.

Contact: www.bsmart-knx.com



KNX MCU-16 AC SMI

BUILDING MANAGEMENT SYSTEMS Binary inputs for direct connection of push buttons, SunControlObject for fast system configuration with just one Group Address, three security objects for plant and personal protection, product libraries and driving strategies for the exact control of any sun protection product – these are functions that have always characterised BMS blind actuators. Combined with the advantages of the SMI protocol, these are reflected in the new MCU-16 AC SMI. 16 SMI drives can be controlled individually or in four groups directly via the push button inputs. All diagnostics and status functions of the SMI are available on the KNX bus – that's what we call intelligence with feedback!

Contact: www.bms-solutions.de



ABB-tacteo

BUSCH-JAEGER The ABB-tacteo KNX sensor is an individually configurable control element for intelligent building management of luxury hotels, public buildings and high-class residential buildings. Each sensor is unique in design and function.

Contact: www.new.abb.com



ComfortClick bOS 5 – New Software Version



COMFORTCLICK has launched a new version of building automation software – bOS 5. In addition to KNX, bOS also supports Dali, Paradox alarm, DSC alarm, IP video cameras, Amazon Alexa, Kodi, Global Caché, IRTrans, Philips Hue and IP intercoms. Especially exciting new features are a simplified configuration process and the configuration examples library which together considerably decrease the time needed for system configuration. Applications are available for iOS, Android and Windows. bOS can be purchased as a standalone licence or pre-installed on one of ComfortClick's servers.

Contact: www.comfortclick.com

24-Channel Multifunction Actuator

CONTROL4U The new LC-A2410 is a multifunction, 24-channel actuator, programmable with ETS to perform different tasks such as switching loads, opening and closing shutters and blinds and operating relays with 10 A maximum load. The relays can be operated manually via a push button mounted on the front of the device. A green LED indicates the switching status of each channel. The power supply is provided by the KNX bus.

Contact: www.lightcontrol-knx.com



KNX Glass Touch Sensor and KNX Room Thermostat with KNX Data Secure



CONTROLTRONIC GMBH The CONTROLtronic glass touch series Living Emotions® offers innovative technology and superior design: Real glass in different colours and finishes, Icons self-exchangeable for one to seven sensor fields, Colour LED illumination RGBW, Proximity detection, Temperature and air humidity sensor and Flat in-wall mounting with invisible magnetic fixing. With the support of KNX Data Secure, the CONTROLtronic KNX glass touch sensors and KNX room thermostats make it possible to set up a secure and protected KNX installation. In commercial buildings, hotels and in outside and public areas of residential buildings - so wherever the KNX bus line is free accessible - protection of the installation by data encryption is essential.

Contact: www.controltronic.com

HomeCockpit touch panel PCs: now with presence detector and Camviewer software!

DIALOGIC SYSTEMS Two mini modules for maximum security. All models of the HomeCockpit touch panel PCs from Dialogic Systems now come with a concealed integrated presence detector as an option to guarantee reliable motion detection, presence monitoring and light control in any indoor location around the clock. As soon as someone approaches, the monitor light is automatically switched on and a telegram is sent by UDP or KNXnet IP. Camviewer software for direct camera control using KNX telegrams is another new feature. Get in touch with the future!

Contact: www.home-cockpit.de/en





New range of Dimming Actuators

DINUY S.A. DINUY presents its new range of dimming actuators. Within this range you can find different solutions for each application, depending on the type of the lamp or driver: RE KNT 004: 4-channel dimmer for 230V or 12V LED lamps or RC loads. Capable of controlling loads of up to 250W on each of the four channels. RE KNT 110: 3-channel dimmer for 1/10VDC drivers or ballasts. It can drive up to 100 devices in total. RE KNT DA1: 3-channel broadcasting gateway for DALI drivers or ballasts. Each channel can manage up to 64 ECGs per channel. RE KNT RGB: 4-channel dimmer for RGBW LED strips. Each channel can control up to 10 A. It can manage four channels independently, RGB+W or RGBW channels.

Contact: www.dinuy.com

9025 CAPACITIVE KNX SWITCH – RGB RANGE

ELECTRON SPA The KNX® 9025 switch range consists of 2-, 4-, 6-, 8- and 10-channel capacitive buttons. Each button can be configured to manage on/off commands, dimming, shutters and blind control, scene recall and control, object sequences etc. Device includes a 2-stage room temperature controller with integrated PI to control heating and cooling equipment, valves, 2- and 4-pipe fan coils etc.

Contact: www.eelectron.com

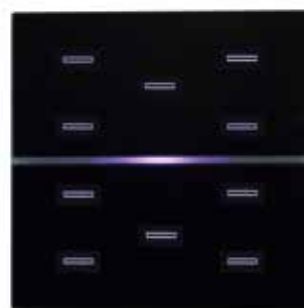

KNX Gateway for JABLOTRON alarm systems

ELAUSYS Integration of alarm systems in a KNX installation offers many advantages. For example, it is possible to control the lights using the motion detectors for staircase lighting or automatically recalling KNX scenarios when the alarm system is armed or disarmed and much more. The KNX gateway enables bi-directional communication with the alarm system. Control and status of up to 32 PGs, control of up to four sections (arm/partial/disarm) and 11 states per section are available (intrusion, entry, exit, fire, ...). Recall of KNX scenes for each status is possible.

Contact: www.elausys.be



Climate and Presence Sensor

ELSNER ELEKTRONIK GMBH With a diameter of only 51 millimetres, the Mini Sewi KNX sensors integrate discreetly into the room. Different versions are available. All models calculate mixed values and have adjustable threshold values, AND and OR logic gates, variable comparators and PI controllers for heating and cooling. Mini-Sewi KNX T is a temperature sensor. The models TH and TH-Pr also measure humidity and calculate the dew point. They have a PI controller for ventilation control. The model TH-Pr additionally signals the presence of people in the room.

Contact: www.elsner-elektronik.de





Data factory and AI for KNX

EMBEDDED SYSTEMS SIA Neural network inside – enabling artificial intelligence and advanced analytics. Connectors to Microsoft, IBM and Amazon cloud platforms. Network and machine learning libraries included. Stream analytics – instantly analyse data from local IoT devices. IoT hub providing bi-directional communication with various supported protocols. Metadata tagging and project Haystack supported.

Contact: www.logicmachine.net

Enertex® MeTa® KNX Standard

ENERTEX BAYERN GMBH MeTa® KNX is a KNX touch sensor and room controller with electronic labels and mechanical rockers. Each rocker can be programmed for use of two or four (left/right) KNX functions. The function is selected with the menu button at the lower end. 16 KNX functions can be implemented. Room thermostat, temperature measurement, humidity measurement, an external binary input for potential-free contacts, feedback and operating symbols are integrated. The high-quality housing made of milled aluminum is available in “brushed”, “black anodised” or “white powder coated” versions.

Contact: www.enertex.de



Lighting system for KNX

ESYLUX GMBH presents a KNX-compatible lighting system with plug-and-play installation and no programming required in the form of the CELINE Quadro sets. A KNX module optionally integrated in the control unit permits seamless integration in KNX building automation systems and means that there is no need to install a separate gateway. This allows the system to be conveniently controlled and read out from a central control point. At the highest configuration level, the system emits biologically effective lighting. With the help of the integrated sensors, ESYLUX's SymbiLogic technology provides the highest energy efficiency with presence-dependent constant lighting control based on the amount of natural light.

Contact: www.esylux.com

EVN-KNX 4-channel dimming actuator

EVN-LICHTTECHNIK GMBH The KNX 4-channel dimming actuator from EVN is suitable for LED unicolour applications due to its compact design, providing a variety of uses for a range of installations. It allows various functions such as relative and absolute dimming, status and error report, selection of 15 different scenes, staircase lighting time, bus recovery and reset function, selection of the preset value, function test via manual buttons and programming via bus voltage. The basic application is available in English and German. Furthermore, the actuator has various protection functions such as short-circuit, overvoltage and overtemperature protection. Further actuators can be found on the website.

Contact: www.evn-lichttechnik.com





Universal Dimmer 2-channel

FINDER SPA The Type 15.2K is a universal dimmer with two channels, each 400 W at 230 V AC, suitable for dimmable LED (100 W); halogen lamps, dimmable CFL lamps and electro-mechanical and electronic transformers. It works with two operating modes: leading or trailing edge, both selectable via ETS. Each channel can be regulated manually via the two buttons on the front for increasing or decreasing the level of brightness. The Type 15.2K is protected against overload and short-circuit.

Contact: www.findernet.com

Room controller ecos505

FR. SAUTER AG The ecos505 is a BACnet Building Controller (B-BC). Its digital communication features (BACnet/KNX/DALI/SMI/EnOcean) seamlessly combine automatic lighting and sun protection control into room climate control. The KNX/TP1 interface allows KNX touch panels, KNX actuators and sensors to be interlinked directly at the programmable BACnet/IP room controller. KNX devices can be configured with ETS using the supported KNX tunnelling without additional KNX bus Couplers. The digitisation of integral room automation is completed with the integrated DALI and SMI interfaces. Used as a BACnet/IP-KNX gateway, the room controller integrates KNX networks into the building and energy management system.

Contact: www.sauter-controls.com

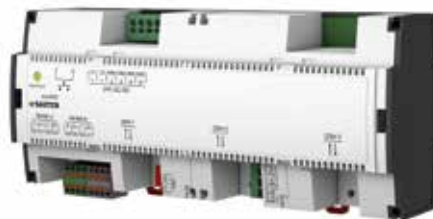

Signal and Alarm Panel – Extension Key



GEPRO MBH The signal and alarm panel KNX-MAT with its 11 RGB-LED, buzzer and acknowledgement button can now be supplemented with the key-operated switch. This is linked with the KNX-MAT with a prefabricated cable with a 4-pole screw connection. The cable can be extended. The key-operated switch is available with different locks. A 5 mm LED in red/green serves as a display unit which is likewise programmed with ETS. The extension unit is produced with a labelling plate or with prefabricated labelling as well as in natural aluminium and black aluminium. It is a component of the GePro 8-fold panel series.

Contact: www.eib-tab.de

ICE Touch KNX touchscreen panel

GEWISS has updated the Chorus ICE Touch commands introducing the new ICE Touch KNX touchscreen panels with interchangeable symbols, backlit by RGB LED. Available in KNX and KNX Easy versions, the new touchscreen panels are a highly customisable design solution to control KNX home automation systems. The coloured, customisable illuminated symbols, enhance the elegance of the glass plate, which is available in three colours: pure white, modern titanium and sophisticated black. The new ICE Touch KNX devices translate the illuminated control device into a multi-sensory experience, combining touch with sight (in the multi-coloured backlighting) and sound (supplied by the acoustic features).

Contact: www.gewiss.com





The new Gira S1

GIRA GIERSIEPEN GMBH & CO. KG The new Gira S1 assures users of the ability to connect easily and securely to their KNX smart home when they are on the move. This is because communication is encrypted. All you have to do is start the Gira X1 app or the Gira HomeServer app – the rest is taken care of automatically by the Gira S1 in cooperation with the Gira device portal. The server for the Gira device portal is located in Germany and is subject to German data protection laws. This ensures that stringent German data protection standards are applied. The Gira S1 can be optimally combined with the Gira X1 and the Gira HomeServer. The app-based remote maintenance and remote control functions are optimally integrated in both. *Contact: www.gira.com/en*

Flush-mounted control module

GUANGZHOU LETOUR LIFE TECHNOLOGY CO.,LTD. The flush-mounted control module is a simple, low-cost smart home system products, which is mainly targeted at existing buildings which have been completed or the intelligent transformation of old houses. The module is installed in the ordinary 86 boxes or 60 boxes, compared with the traditional lighting wiring and control. Just by adding an extra KNX bus, you can transform the original traditional lighting solutions into a intelligent home control system. The installation is simple and convenient. This system includes: output control (3-channel relay output, 10 A/channel; can be expanded to nine channels; 1-channel dimming output, 200 W/channel; 2-channel shutter output), dry contact panel input (6-channel dry node input) and panel indicator display (6-channel LED output).

Contact: www.gzletour.com



KNX 24/12-Fold 10A Switch/Shutter Actuator

GUANGZHOU VIDEO-STAR INTELLIGENT CORP.,LTD AMRW-24/10.1, 10A/105uF. The switch/shutter actuator is a multi-output module, providing 24 channel switch outputs or 12 channel shutter outputs. You can configure the functions of the module according to your requirements, such as using some channels as switch outputs and other channels as shutter outputs. The shutter type can be selected for the blind and the shutter while the motor type can be selected for the AC motor or dry contact motor.

Contact: www.video-star.com.cn



New 5.6" Touch Panel

HDL is proud to present its second generation 5.6" KNX DLP Modern Touch Panel. Able to effortlessly manage an entire building or a single room, the DLP Modern unifies KNX installations for a truly holistic control experience. With a smooth uninterrupted glass exterior, a high contrast, energy-efficient LCD display and an aluminum unibody enclosure, the panel is a seamless blend between power, style and practicality. Intuitive and effortless to use, the 29 x 84 mm display boasts proximity activation and auto button indication. With four dedicated shortcut keys and eight easy to navigate control pages capable of controlling 120 KNX objects, this versatile yet compact panel is perfect for any KNX project. *Contact: www.hdlautomation.com*





Binary interface w. outputs

HUGO MÜLLER GMBH & CO KG The new binary interface EA 36.32 KNX can be used as a universal interface, e.g. for conventional push buttons. Three independent, integrated binary inputs allow the realisation of multiple applications such as blind control or light control (dimming). One of the inputs can be configured as an input for an external temperature probe (PT1000), which works well with the integrated room temperature controller. Two additional outputs can be configured either as LED driver or as OPEN-COLLECTOR outputs. Various options and parameters within the ETS application offer adaption to multiple solutions.

Contact: www.hugo-mueller.de

Iddero Verso IP

IDDERO introduces the new Verso IP – an evolution from the acclaimed Iddero Verso 4.3" KNX capacitive touch panel. The new Verso IP retains the elegant design, attractive visualisation and advanced functionality from the base model and adds an Ethernet port for IP connectivity. Remote control is now possible from smartphones and tablets via native mobile apps (iOS and Android). The mobile apps closely mimic the device user interface, so no additional learning is required. Both direct (LAN) connection and cloud-based operation are supported; zero-configuration required. Communications are fully encrypted and 100 % secure. With the new Verso IP you just can't go wrong.

Contact: www.iddero.com



iHaus App: Connects KNX & IoT

iHAUS AG The professional hybrid solution for all Smart Home situations: iHaus is a unique platform to link and control KNX automated devices with many other intelligent IP based Smart Home devices, no matter which manufacturer, brand or system they work with. In combination with any KNX IP router or gateway the iHaus App enables commands between KNX and other systems like Apple HomeKit, Ikea Tradfri, Home Connect, Sonos, Philips Hue or Amazon Echo, which can be set and called up individually – even by voice command to assistant Alexa or via touchscreen from out of home. An additional hub or gateway is not necessary, iHaus uses iOS or Android smart mobile devices as server solution.

Contact: www.ihaus.com/en



New IntesisBox® BACnet IP/MSTP Server to KNX gateways

INTESIS SOFTWARE IntesisBox presents its new generation gateway IBOX-BAC-KNX for integrating KNX systems into BACnet Server building management systems (BMS). The gateways have a direct connection to KNX TP from one side, and to BACnet IP and MSTP from the other. All of them are now BTL certified. IBOX-BAC-KNX is available in five versions supporting 100, 250, 600, 1200 and 3000 points, all of them offering bi-directional control and monitoring of the integrated data. New features like BBMD/Foreign Device, calendars, schedules, notification class have been added. These new generation gateways are easily programmed by using our brand-new software IntesisBox MAPS.

Contact: www.intesisbox.com



IPAS DALIControl gc16



IPAS GMBH The IPAS DALIControl gc16 combines complex lighting functionality and economic efficiency in one device. Specifically developed for a wide spectrum of applications, up to 64 DALI lights are controlled in up to 16 groups. The DALIControl gc16 is programmed entirely with ETS5. The DALIControl gc16 is one of the first KNX/DALI gateways that supports all common device types as well as specifically the current device type eight for colour control (colour temperature (DT-8 Sub-Type Tc), XY-colour range (DT-8 Sub-Type XY), RGB (DT-8 Sub-Type RGBWAF), HSV (DT-8 Sub-Type RGBWAF), RGBW (DT-8 Sub-Type RGBWAF)).

Contact: www.ipas-products.com

iRidium server UMC C3

IRIDIUM MOBILE iRidium server UMC C3 is a controller for automation systems, including KNX and IoT devices. It supports KNX and other systems. It has built-in Global Caché IR database and much more. It supports javascript, block schemes, has a built-in engine for schedules and rules. Extensive API, database generation and an extremely beautiful UI with freehand graphics make it very different from most KNX solutions on the market. IoT-oriented approach gives you access to connection to cloud services with data analytics and the capability for personal developments. The new C3 model has WiFi, RS-485, that can be used as an output to other systems.

Contact: www.iridiummobile.net



ise smart connect KNX viega

ISE INDIVIDUELLE SOFTWARE UND ELEKTRONIK GMBH Fonterra Smart Control from viega is a completely new type of single-room control in surface temperature control. With the ise smart connect KNX viega, up to five Fonterra Smart Control base units can now be conveniently integrated and controlled in the KNX system. Up to eight room temperature sensors and 12 outlets can be connected to each base unit. Control and visualise your room temperature via KNX. Also system information like system status, error messages, upcoming firmware updates etc. can be conveniently displayed.

Contact: www.ise.de

JUNG KNX Energy Sensor

ALBRECHT JUNG GMBH & CO. KG Greater energy efficiency thanks to new, high-performance software: The KNX 3-fold energy sensor has been expanded with the 'converter measurement' function. As an alternative to the direct measurement of three circuits up to 16 A, the JUNG device can now also measure the total private home consumption or commercial consumers up to 75 A via converters. The KNX energy sensor detects consumption as well as the supply. This offers improved opportunities for energy-efficient management in private and commercial buildings.

Contact: www.jung.de/en



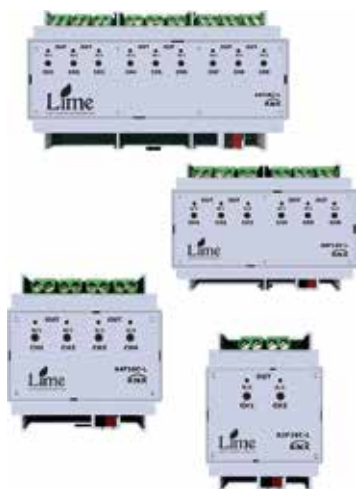

The Netra series – KNX Switching Actuator

LIME INTERNATIONAL The Netra series of switch actuators are especially suited for high loads as well as capacitive loads, with high start-up peak (C load). The load for each channel is 16 A at 250 V AC. Each channel can be assigned its own mains and is connected to a screw terminal. Each channel has a button for manual operation and a LED for switching. Available with two, four, six and nine channels.

Contact: www.lime-smart.com

Glass Touch Thermostat (MTH10xx-TL)

MAKEL ELEKTRIK Room temperature controller with 10/6 capacitive touch buttons that can be configured to manage diverse KNX functions: On/off, dimming, shutter/blinds, scenes, ... The room temperature controller can operate in two stages (main controller + auxiliary), work in on/off (hysteresis) mode or PID regulation for heating and cooling; fan control as well as heating/cooling automatic switch-over if desired. Four logic channels configurable to execute logic operations or copying and routing of GAs. Its front glass with OLED display gives it a sophisticated look. Comes in any combination of black/white, square/oval glass.

Contact: www.makel.com.tr/en



MDT push button Smart86 with temperature sensor BE-TAS86T.01

MDT TECHNOLOGIES GMBH The MDT push button Smart86 with integrated 86 mm frame in pure white glossy has six mechanical push buttons with finger recess. It can be universally used as a 4-/6-/8-/12-fold push button. With the slap function, 13 switching functions are available on up to three levels. A large colour display is used for function/status display. The texts are freely adjustable and symbols can be loaded. The brightness of the display adapts automatically to the environment. The extensive application also allows Tunable White and HSV colour control. It measures the room temperature and enables efficient room temperature control with the heating actuator. Operating mode and setpoints can be set conveniently.

Contact: www.mdt.de

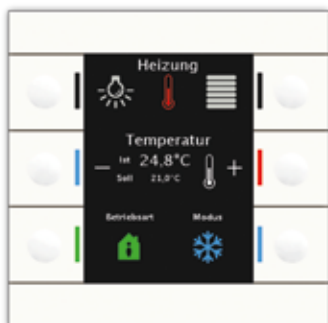

KNX DALI-Gateways Basic

MERTEN GMBH The DALI category I controllers from Merten GmbH with integrated power supply provide the control of up to 64 ECGs in broadcast mode, in 16 DALI groups or 16 scenes. Push buttons allow manual control per group or broadcast. DALI DT8 lamps can be controlled with KNX sensors i. e. tunable white, RGB, RGBW, XY, and HSV. Analysis is supported by operating hours' counter and failure messages and can be visualised via KNX. 16 weekly timers for brightness, colour and fading time with 300 commands enable the control of repeating applications. Additionally, the devices provide a staircase timer function with prewarning, normal, permanent, night and panic mode. 1-channel: MEG6725-0003, 2-channel: MEG6725-0004.

Contact: www.merten.de



EiPlan-outside



NAUTIBUS ENGINEERING The well-known ETS app EiPlan is now also available in a stand-alone version. “EiPlan-outside” can be used independently of the ETS for the planning of KNX projects. It is easily installed on Windows 10 and is 100 % compatible with the ETS app version EiPlan5. It can take over and edit projects and devices from EiPlan5 or create new projects. EiPlan-outside cannot import devices from the ETS catalogue or program them on the bus. It is therefore especially suitable for expanding the planned workplaces. EiPlan-outside can be ordered directly from Nautibus engineering.

Contact: www.nautibus.de

NETx LaMPS for DALI tests

NETxAUTOMATION SOFTWARE GMBH To reduce the complexity for system integrators who are using KNX/DALI gateways in their projects, the NETx LaMPS module is now available. It eases the management of KNX/DALI gateways by providing an interface to initiate DALI testing independently from the KNX/DALI gateway vendor used. All DALI gateways/devices are represented in a uniform data point view as BMS Server Items, no matter which vendor they come from. Besides monitoring of operating hours, current and voltage, thresholds and alarms can also be defined. If no smart meters are available, a rough estimation of power and energy can be made. For comfortable handling, an automatic import from ETS5 using the NETx BMS App Secure is supported.

Contact: www.netxautomation.com



mono.HUB



NOMOS SYSTEM AG Did you always want to make your home an automated one, but were hesitant because of costs, complexity and security? Well, that is over now. nomos reveals its first product after years of research in automation across industries; the mono.HUB. Your emancipation above standards and cloud necessity, to reach the power of local independence at a dizzying new price. nomos opens a new chapter in a stiff distribution market. Keep your house at the pace of your phone's innovation. mono.HUB gives you compatibility to Apple TV, NetAtmo, Samsung, HUE, KNX and makes them available on your phone regardless of your preference. No hidden or ongoing costs. You purchase the mono.HUB once, and it belongs to you. Innovation should neither be inhibited by technology constraints nor by money. Join the movement, to come across #technicalemancipation with nomos.

Contact: www.nomos-system.com

DALI Pro KNX lighting control

OSRAM GMBH The DALI Pro light management system with direct KNX connection. Group and scene control even for entire floors. Integrated light control functions such as switching, dimming, presence detection, daylight harvesting and scenes, as well as features for colour temperatures (TW), coloured light (RGB) and dynamic colour changes (e. g. HCL, daylight simulation) – also with real-time clock and via the smartphone/iPad app. A DALI Pro KNX controls up to four DALI channels with up to 64 addresses and 50 sensors each. To implement larger projects, four devices are combined to a control system via LAN. Group Addresses can be freely assigned via the DALI Pro software.

Contact: www.osram.com



Controlmini by PEAKnx – A reliable all-rounder with style



PEAKNX The Controlmini is a high-quality control panel for the perfect smart home. At only 11.6". The elegant multi-touch panel can be integrated harmoniously into any room. Replaceable cover glasses allow an infinite number of designs. All standard visualisation software can be installed on the preinstalled Windows 10 Pro operating system to use the touch panel for home or room control. It is also suitable as a status and information display or as an intercom system. The attractively priced panel is available as a flush-mounted and surface-mounted variant.

Contact: www.peaknx.com

Building Automation and Energy Efficiency

PROGEA SRL A supervision system developed with Progrea's Movicon has replaced degraded software installed in two manufacturing sites belonging to an important company in Emilia Romagna, a leading hydraulic valve manufacturing company. The supervision system completely monitors and controls the entire plant using KNX sensors, such as temperature probes, lux meters, humidity and CO₂ sensors for instance, to manage the plant's climate, air, windows, lights, burglar alarm systems and information deriving from measuring instruments. All the data, alarms, measures and states can be analysed by means of using charts and reports.

Contact: www.progea.com/en



Voice Control and Alerts

PROKNX SAS RealKNX is the first KNX device certified for Google Assistant. Just activate Google Action, and all KNX functions (lights, blinds, heating, scenes, status, etc.) are translated for Google Assistant. Both Google Home and the mobile phones (Android + iOS) understand spoken sentences. On the other hand, it is possible to receive alerts by voice: A motion detector can "report" that someone is approaching the house. Triggering the smoke detector will alarm and indicate the escape route. With only one configuration through an ETS product entry, RealKNX additionally provides voice control via Siri and Alexa. It includes the powerful IoT and logic editor Node-RED and it is a full-fledged visualisation system.

Contact: www.proknx.com



Blind Control Centre with 9.7" touch display

SCREENTRONIC GMBH The ScreenTronic® Blind Control Centre with 9.7" touch display is the ideal shading system with sun tracking possibility for venetian blind slats to realise efficient sun protection for buildings. Based on an iPad with wall mounting solution (glass frame for flush and fixed installation of an iPad) and ScreenTronic® iOS app, the direct control of venetian blinds via KNX IP (Routing and Tunnelling) is possible. The shading by neighbouring buildings can be considered.

Contact: www.screentronic.com



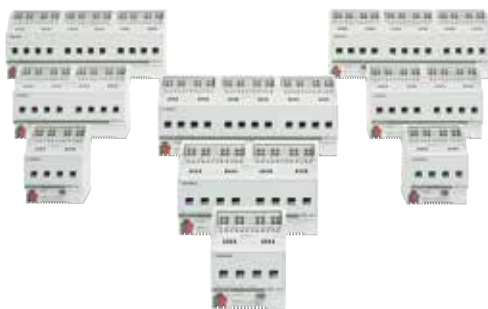

High-performance switch actuators

SIEMENS AG The new switch actuators, featuring four, eight and twelve channels each for 6, 10 and 16/20 A, can handle capacitive, inductive and resistive loads. Stand-out features include maintenance-free terminals for rapid connection and simple looping-through of untreated conductors. The basic function of switching with status message can be extended by logical and timer functions via ETS, as well as override functions such as manual ON, continuous OFF, or priority control. The diagnostic functions also allow monitoring of limit values based on operating hours elapsed and switching cycles.

Contact: www.siemens.com/gamma

Full room automation with the new KNX thermostat from Siemens

SIEMENS SWITZERLAND LIMITED Full room automation is now an option in many more projects: The new Siemens room thermostat RDF600KN combines both room climate and room automation in just one compact device. This significantly reduces both hardware and installation costs. RDF600KN is especially suited to hotels and commercial buildings: It provides temperature control, light switching and dimming, shading and special scene selection. RDF600KN has multiple pre-loaded HVAC applications, including 2- and 4-pipe fan coil and universal applications, so no programming is needed. It can be mounted on standard CEE/VDE conduit boxes and integrated in building management systems for remote control and service.

Contact: www.siemens.com/thermostats



Slim – IR Quattro SLIM XS KNX



STEINEL VERTRIEB GMBH With an installed height of only 6 mm, the extra-slim IR Quattro SLIM XS KNX presence detector from Steinel Professional is virtually invisible. It fits into any standard concealed box. Despite its unobtrusive appearance, the IR Quattro SLIM XS KNX is a high-precision, 360-degree infrared sensor with the only retina lens of its kind in the world. Its square presence detection zone of 4 x 4 m makes it the preferred choice for watching over individual workplaces. For practical convenience, all settings can be made via remote control or smart remote. For added installation flexibility, it is available either as a round or square version and, on request, also for surface-mounting.

Contact: www.steinel-professional.de

KAlstack with KNX Secure support

TAPKO TECHNOLOGIES GMBH Due to growing demand for secure communication, TAPKO is offering full KNX Secure support in its latest release of KAlstack the KNX communication software. In spite of increased complexity, the application developer has almost no additional effort despite KNX Secure. Updating existing KAlstacks and applications is a straightforward process. The required update ability is satisfied with a sophisticated robust remote update process for re-programming the complete firmware – KAlstack and application. Since KNX Secure has also hardware impacts, new hardware EVAL boards are offered for evaluating.

Contact: www.tapko.com



KNX touch panel with new design



TCI GESELLSCHAFT FÜR TECHNISCHE INFORMATIK MBH The new luna design touch panels from tci ambiente impress with a continuous, frameless glass front. The bi-colour LED in the front panel can be configured for various applications, e. g. to display a door call during periods of absence. The digital input allows a bell push button to be connected directly. The capacitive multi-touch displays with 7, 10, 16 or 22 inch are particularly bright. Thanks to the integrated temperature sensor, the panel can be used as a room controller. The pure KNX version is equipped with a KNX interface. The integrated visualisation can be parameterised via ETS and is interoperable, for example, with Sonos and Philips Hue.

Contact: www.ambiente.de/en/

Eyeswitch

TENSE BVBA The Eyeswitch is an elegant and handy iPad mount with integrated charger and a dedicated LAN connection which is combined with an 8-fold KNX Intensity touch button. Slide one of the current iPads horizontally or vertically in place and in a few seconds your iPad becomes wall-mounted. Thanks to the KNX switch you can easily operate your KNX home automation, even when the iPad is not present. It is easy to dismantle the iPad and supporting bracket while maintaining a sleek designer look thanks to the 8-fold Tense Intensity switch. This product will be available in all metal types, Corian® and wood.

Contact: www.tense.be



Qt for Automation



THE QT COMPANY We at Qt think that developing should be fast, fun and easy. That's why we introduced QtKnx to our Qt for Automation offer: to let you create high-performance, tailor-made and flexible UI's for smart buildings. With the QtKnx library, you can integrate different functionalities (e.g. speech recognition) and technologies (e. g. BLE) allowing you to switch on a light with just a few lines of code. Based on C++, there are no limitations to hardware, software or operating systems. At Light + Building 2018, we will demonstrate a client implementation on how to control the lights in your home by using KNX as the communication protocol between the control board and lights.

Contact: www.qt.io

Voice control for KNX

THINKA for KNX allows homeowners to interact with their home in a very user-friendly manner. Just like you drive your car, you should be able to interact with your home: smart, safe and comfortable. When leaving the car, who leaves on the lights, the music and the heating, after all? The spectrum of services: Thinka delivers voice control for KNX. By means of a very straightforward import of an ETS project, home owners can interact using their voice. Currently Thinka supports lights, switches, blinds, curtains, climate control as well as motion, CO₂, contact, occupancy sensors.

Contact: www.thinka.eu/en





The new ThinknX Envision T

THINKNX Envision T completes the ThinknX all-in-one touch panels. In addition to KNX TP connection, embedded temperature and humidity sensors let the Envision become a complete chronothermostat, with several regulation algorithms and weekly scheduling. Up to two loads can be controlled with relays on board and four inputs can be configured to receive digital or analogue signals from several kinds of third-party devices. Three IR transmitters can be arranged in the building to control HVAC splitters and all the other IR-controlled devices. Its elegant design has been enforced with a new set of top-quality materials to make it more adaptable to the latest architectural trends thanks to frame in Fenix NTM. *Contact: www.thinknx.com*

WAREMA KNX sun shading actuators MDRC

WAREMA RENKHOFF SE Warema KNX actuators are DIN-rail mounted devices that can control between two and eight sun shading drives of 230VAC or four sun shading drives of 24VDC independently of each other. The easy-to-change miniature fuses are standard features and ensure the optimum line protection of the connected components. They are integrated directly in the actuator and offer significant assembly benefits because they require no external line protection. In order to guarantee the optimum energy utilisation, the manual control can be limited by the available automatic byte inputs.

Contact: www.warema.com



KNX IP Multi IO 580

WEINZIERL ENGINEERING GMBH The KNX IP Multi IO 580 is a universal input and output device with 48 channels for direct connection to KNX IP. Each channel can be configured as input or output. The inputs are designed for dry contacts and can be used to control e. g. lights or blinds. The outputs can control signal LEDs or external coupling relays. With the IO extensions 590 and 592 from Weinzierl, bi-stable relays and shutter relays are also available. The device is also available as a TP version with an integrated USB interface. Both devices offer a fast download via IP or USB. An OLED display on the front allows manual operation. *Contact: www.weinzierl.de*

Timberwolf Server 950

WIREGATE The Timberwolf Server 950 is a multi-interface server for DIN hat rails. Its KNX stack allows 8000 objects/64000 associations and 25 tunnels simultaneously. 100 million telegrams and 5000 values/timelines are logged permanently for deep analysis, also via SQL. NTP time synchronisation and connection via VPN is also integrated. Additional KNX Interfaces can be appended. Further interfaces are two RS485 or DMX for lighting control, CAN-Bus, RS232 serial interface and three ports for 1-wire bus to handle up to 80 1-wire slaves each. Modern, fully encrypted, responsive web interface for setup, logic engine, and VISU, for all devices. *Contact: www.wiregate.de*



Pairot KNX-Homekit bridge



XXTER BV “Siri, dim the lights in the living room” or “Siri, we’re going to bed” is now available for homes with KNX. xxter has created the KNX-Bridge “Pairot” in close coordination with Apple and is therefore allowed to officially proclaim that it “Works with Apple HomeKit”. Pairot is connected to the home network and the KNX installation and with simple configuration, the components in the home can be voice controlled with Siri and Amazon Echo. Siri, through Pairot, can easily control the available switches, dimmers, shutters and thermostats and can read sensor values like temperature, light intensity and humidity, of course only when these sensors are available in the home.

Contact: www.xxter.com/pairot/en

Interra Iswitch

YÖNNET BİLİŞİM Interra Iswitch brings functionality and design together for the user. With its sleek and stylish design, the iswitch stands out due to its features. With a wide choice of materials and colours, it offers harmony over all expectations. Intelligent control provides energy efficiency while at the same time your living space gains in comfort and aesthetic appeal. Iswitch, with the new generation of automation switch, can provide self-direction. For instance, the ambient detector automatically adjusts the light level. Moreover, through the Iswitch PI control feature, it can learn spontaneously and perform the desired functions in the room.

Contact: www.interra.com.tr



AudioInRoom

ZENNIO AVANCE Y TECNOLOGÍA SL AudioInRoom is the new KNX native Zennio audio controller for hotel rooms, which allows guests to play music from their own smartphone through Bluetooth connection or from an auxiliary audio input (such as TV). It has two stereo channels (20 W), so that you can enable/disable, mute or adjust volume in two independent areas. Bluetooth pairing is restricted via passwords to make sure the guest is connecting to the audio system in their room.

Contact: www.zennio.com

KNX Energy Harvesting Switch

ZF FRIEDRICHSHAFEN AG The KNX-RF certified, ZF switch module is the first which does not require batteries, making it truly maintenance-free. This RF module is easily programmed in ETS5 and using the ZF Media Coupler you are directly connected to the KNX bus. Choose the function, light switch or blind control and up to six separate buttons can be programmed. With reliable ZF energy harvesting technology, it's now possible to extend existing KNX networks with wireless switches. Get further details about the “KNX product of the year” (KNX Groep B.V. Netherlands) from ZF on our homepage.

Contact: www.switches-sensors.zf.com



Effective protection against water damage



ZIDATECH AG The leak sensor from JUNG detects leaks before they can cause major damage. Therefore the sensor must be simply connected with a 2-core cable to KNX push button interfaces and installed directly under baths, shower trays, washing machines, kitchen cabinets or boilers. If unwanted water escapes, the device signals it immediately and shuts off the water supply. The leak sensor therefore offers a high level of protection against water damage, saving time, money and your nerves. In Switzerland exclusively available from ZidaTech.

Contact: www.zidatech.ch

The five second installation

ZÜBLIN ELEKTRO GMBH The Swiss Garde 360 Präsenz KNX/KLR offers a fast installation with a very discreet and well-designed visible component. It is one product out of an identical family. You know one product, you can handle all installation situations. The product family offers spring clips, flush mounting and surface mounting IP20 to IP55. Functionality focused on light control and presence detection. To ease the commissioning, the functionality is optimised for on/off or daylight control with a wide variety of uses such as manual override, standby light, presence detection, lighting scenarios and runtime configuration of time and lux value. Ideal for KNX applications in offices, class rooms, meeting rooms etc.

Contact: www.en.zublin.de



THE KNX DEVELOPMENT MICROSITE

Find all you need to know to understand KNX technology and all the available possibilities to start developing KNX products. This microsite contains multiple resources for developers, including some that have never been published before. Do not miss it!

development.knx.org





National Groups

KNX National Group Belgium Organises Knowledge Event

BELGIUM The KNX National Group Belgium organised a “Knowledge Event” that took place on 23 November in Antwerp. Around 70 architects, consultants and end-users were welcomed by the national group to hear about the automation of real estate projects, and learn more about KNX and the possibilities of using it to link smart devices.

Contact: Rob Van Mil | info@knx.be | www.knx.be



Architects, consultants and end users fascinated by the possibilities that KNX offers.

KNX Chile Raises the Bar at Matelec Latin America

CHILE With a superb stand and a fully-booked seminar at the Matelec Latin America show, KNX Chile highlighted once again how KNX solutions meet the needs of smart homes and buildings, locally and internationally. This was the most popular stand at the fair and enjoyed a constant flow of visitors. All involved agreed that this was the most successful event of 2017, creating many leads and new business opportunities for KNX Chile.

Contact: Gerald Esparza | info@knx.cl | www.knx.cl



The welcoming KNX Chile stand at Matelec Latin America.

KNX Draws Crowds at Shanghai Intelligent Building Technology

CHINA 2017 was a great year for KNX National Group China in spreading the KNX message all over country. At the SIBT (Shanghai Intelligent Building Technology) event for example, the KNX China stand was completely crowded for most of the day. Visitors had the opportunity to check the interoperability of KNX devices from various KNX manufacturers, and participate in a fully-booked KNX seminar.

Contact: Shen Pu | info@knxchina.org
www.knxchina.org



Crowds at the KNX China stand at SIBT.



The popular KNX Colombia stand at Expoconstrucción.

KNX Colombia Excels at Expoconstrucción

COLOMBIA KNX Colombia was the centre of attention at the 2017 edition of Expoconstrucción, one of the leading construction fairs in Bogotá. Even though KNX experienced outstanding growth of 35 % in terms of certified KNX Partners, interest in the KNX booth still exceeded all expectations. KNX is doing more than setting foot in Latin America – it is leading the way!

Contact: Erika Rodriguez | secretario@knxcolombia.org
www.knxcolombia.org

Technology Conference Success in Czech Republic

CZECH REPUBLIC The annual Lighting Technique Conference, held in North Moravia, is one of the most important events for exchanging knowledge about KNX system installations in the Czech Republic. At the 2017 event, the focus was on the openness of KNX and its suitability for all kinds of application. The conference was attended by more than 200 designers, contractors and end-users.

Contact: Josef Kunc | eibsyst@volny.cz
www.knx.org/cz



One of the KNX lectures at the Lighting Technique Conference.



KNX France stand at IBS 2017.

KNX France Makes Big Impression at IBS 2017

FRANCE IBS 2017 saw KNX France exhibiting for the 8th time at the show. With a new location right at the entrance, and the exclusive distribution of KNX bags throughout the show floor, KNX was visible everywhere. Many new products as well as ETS software were presented at the stand, and visitors were treated to several speeches and a cocktail party with games and other surprises, all organised by KNX France.

Contact: Amel Karim | contact@knx.fr | www.knx.fr

KNX Germany Highlights Integrated IoT at ZVEI Colloquium

GERMANY At the recent ZVEI (German Electrical and Electronic Manufacturers' Association) annual Colloquium in Frankfurt, KNX Germany shared its roadmap of a KNX system that is fully IP-based, with an audience of over 250 people. There was also a clear focus on the integration of the many millions of currently-installed KNX 'classic' devices into this IP-based solution.

Contact: Hajo Deul | knx@zvei.org | www.knx.de



KNX Germany talks about KNX IoT at the ZVEI Colloquium.



Suvankar Das and Bhavesh Doshi of KNX India.

KNX India Scores High at Greenbuild India

INDIA The influence of KNX in India is reaching new heights. One of the many indicators is that KNX India gets regularly invited to participate in events and explain the benefits of an open standard. One such event was the recent Greenbuild India international conference and exposition, where KNX India's contribution was hailed a great success.

Contact: Bhavesh Doshi | info@knx.in | www.knx.in

KNX Italy Awards 2017

ITALY KNX Italy celebrated its annual KNX Day in Milan, at which the 7th edition of its KNX awards were held to honour the five best KNX projects in Italy. A new introduction to the day was the "customer game" whereby the audience was asked to split into groups and come up with unique selling proposition in less than 15 minutes, the results of which were critiqued by a professional sales coach.

Contact: Filomena d'Arcangelo
segreteria@konnex.it | www.knx.it



Proud winners of the KNX Italy Awards 2017.



Mr. Shimizu introduces Microsoft's plans for smart homes and buildings at the KNX Roadshow Asia.

KNX Roadshow Asia Kicks Off with Enthusiasm in Japan

JAPAN The KNX Roadshow Asia kicked off in Japan and saw 60 guests treated to presentations from guest speakers from Microsoft and Toshiba, who explained why KNX is, thanks to its openness, the right choice for Japan. The roadshow also highlighted KNX developments in Japan over the last four years, and showed how the technology has a bright future in Japan and throughout the world.

Contact: Takayuki Shintani | knxjapan@itrco.jp
www.knx.org

KNX Roadshow Asia Concludes with Major Success in Seoul

KOREA The KNX Roadshow Asia ended with an event in Seoul that was hosted by KNX National Group president, Daniel Lee. During various presentations and discussions, 70 participants were updated about the current status of KNX in Korea, and the latest developments including KNX IoT, KNX Secure and ETS Inside. The event concluded successfully with a lucky draw.

Contact: Daniel Lee | info@knx.or.kr
www.knx.org/kr



Daniel Lee opens the KNX Roadshow in Seoul.



KNX Days 2017 allowed an in-depth exchange of knowledge and ideas.

KNX Days 2017 in Luxembourg

LUXEMBOURG The KNX Days 2017 took place at the National Vocational Education and Certified KNX Training Centre CNFPC in Esch/Alzette. Exhibitors presented the latest KNX products and solutions for intelligent buildings, and the event was concluded with a presentation by Michael J. Immecke of DIAL, who talked about the responsibilities and skills of building management designers.

Contact: *Alphonse Massard | info@knx.lu | www.knx.lu*

KNX Netherlands at National Conference for Building Automation

NETHERLANDS KNX National Group Netherlands took part in the National Conference for Building Automation in Amsterdam, 1-2 November. The national group gave several presentations at the anniversary edition of this event, which was held at Taets Art & Event Park, and was also present with a stand in order to inform the public about KNX, its products and its activities.

Contact: *Rob van Mil | info@knx.nl | www.knx.nl*



One of the many presentations given by KNX Netherlands.



Colin Price opening the annual KNX Day

KNX New Zealand Awards

NEW ZEALAND KNX New Zealand held its annual event in Christchurch, where the main focus was the KNX NZ Awards. These were handed out in three categories: best product – shared between Theben and Wago; best residential project – won by Ease Integration; and best commercial project – won by Aotea Electrical.

Contact: *Colin Price | info@knxnz.org | www.knx.org.nz*

Gliwice Hosts KNX Poland Conference

POLAND The second KNX Home Automation Conference by KNX Poland took place in Gliwice. The one-day seminar, which was also supported by various KNX members, included a seminar, various workshops, a small tradeshow and a closing dinner. The audience, which ranged from students to installers and system integrators, discussed many topics and unanimously agreed that the show was a major success.

Contact: *Jan Worobiec | jan.worobiec@targetpress.pl | www.knxpolska.pl*



The spacious KNX Home Automation Conference venue.



KNX Portugal stand at the Concreta trade fair ready before the opening.

KNX Portugal Exceeds Expectations

PORTUGAL A growth in members, the successful launch of ETS Inside and an increased presence in the media are just some of the highlights that made 2017 a great year for KNX Portugal. The national group also participated in three trade fairs, culminating with the Concreta trade fair in Leca da Palmeira.

Contact: Rui Horta Carneiro | rui.carneiro@knx.pt
www.knx.pt



KNX Handbook in Romanian

ROMANIA In addition to its existing technical seminars and KNX basic certification training, KNX Romania is delighted to announce the launch of the "KNX Handbook" in Romanian. The book is already available online and the official launch of the printed version is soon to be announced on the national group's website www.knx.ro.

Contact: Rafael Marculescu | presedinte@knx.ro
www.knx.org



KNX Handbook in Romanian.



KNX Russia stand at Interlight.

KNX Russia Looks Back at Best Year

RUSSIA 2017 has been the best year so far for KNX Russia. With four KNX PlugFests in cooperation with various members and institutes, two tradeshow and a new strategy for the future, the position of KNX has been greatly strengthened in the Russian market. KNX Russia also plans a KNX roadshow in three major Russian cities.

Contact: Andrey Golovin | golovin@konnex-russia.ru
www.konnex-russia.ru



KNX Spain Addresses Hotel and Tourism Sector

SPAIN KNX Spain held a two-day congress, Smart Technology Forum - Hotels 4.0, in Mallorca for the hotel and tourism sector. This exceeded all expectations with 200 participants attending. The first day was dedicated to hotel technicians and covered innovative solutions for energy efficiency, communication security and guest satisfaction. On the second day, general topics were discussed, including the impact of IoT on this sector.

Contact: Michael Sartor | info@knx.es | www.knx.es



Fully-booked KNX Spain congress.



KNX presentations eagerly awaited by local community.

Successful Roadshow for KNX South East Asia

SOUTH EAST ASIA KNX plays a major role in the South East Asia market, so it comes as no surprise that the Singapore leg of the KNX Roadshow was a great success once more. Presentations on KNX developments were warmly received by the eager participants, in particular the KNX IoT roadmap which highlights the sustainability of KNX and its suitability to this advanced and driving market.

Contact: Stella Toh | stella@stellarcorp.com.sg
www.knx.asia

Two KNX Award Winners in Sweden

SWEDEN KNX Sweden has been organising a KNX award ceremony annually since 2006. The 2017 ceremony had two winners: Staffan Frölinger of installers Midroc, who won the main award for an efficient way of upgrading subway stations in Stockholm, and Kenneth Kilheim of installers Kilheims Elektrisk, who won the special award for his KNX solution for villas, that costs the same as a conventional installation.

Contact: Jan Hammersköld | info@knx.se
www.knx.se



Proud winners of the KNX Sweden Awards.



Swiss BIM guide.

KNX Switzerland Publishes BIM Guide

SWITZERLAND In cooperation with various expert groups, KNX Switzerland released the KNX Switzerland BIM (Building Information Modelling) Guide. Aimed at systems integrators, the guide looks at typical KNX tasks in the context of BIM, and is available on the KNX Switzerland website since January 2018.

Contact: René Senn | knx@knx.ch | www.knx.ch

KNX Taiwan Elects New President

TAIWAN KNX Taiwan elected Solomon Lee as its new president at a national group meeting. With highly-motivated members and a strong focus on training, the group is looking forward to a successful year ahead. The meeting was followed by a KNX Taiwan forum that was attended by more than 50 participants and provided a great opportunity to learn more about KNX and the development of KNX Taiwan.

Contact: Solomon Lee | solomonk@ms48.hinet.net
www.knx.org/tw



Solomon Lee delivers speech about KNX in Taiwan.



KNX UK stand at Smart Building Show 2017.

KNX UK at Smart Building Show 2017

U.K. KNX UK had an impressive presence at the Smart Building Show, part of the massive UK Construction Week event, and once again showed thousands of visitors why KNX is the leading system. KNX was showcased throughout the hall, and the presentation by KNX UK president, Iain Gordon, was one of the most anticipated talks of the whole concurrent seminar.

Contact: Tara Gartland | admin@knxuk.org
www.knxuk.org

KNX USA at CEDIA in San Diego

USA KNX USA was very pleased to have increased its visibility at the CEDIA Show 2017 in San Diego. Since the first appearance of KNX USA at CEDIA in Dallas 2015, several KNX manufacturers have chosen to be present at the fair with stands of their own, pushing KNX technology even further in the USA.

Contact: David Thurow | info@knx.us | www.knx.us



KNX USA stand at CEDIA 2017

Start@KNX

ARE you looking to expand your knowledge about KNX? "Start@KNX" offers an overview of the various training options, accompanying material and identifies how teaching materials and methods can effectively be used in order to increase knowledge about KNX. Find all info at <https://start.knx.org>



KNX®



KNX Secure

THE new KNX Secure pages offer you all information and material about security measures, which are implemented in the KNX Standard. KNX secure guarantees you the highest security, which is available in the market for home and building control.
<https://KNXsecure.knx.org>



KNX Userclub / Professionals

KNX Professionals Belgium Network Meeting

BELGIUM KNX Professionals Belgium organised a network meeting for members and potential members. The meeting started in the afternoon and ended with a business market and a networking drink. During the afternoon sessions, the national KNX awards were handed out. Domotechnology won the award for best commercial KNX project, and Dynamitec won the award for best residential KNX project.

Contact: Rob van Mil | info@knx-professionals.be
www.knx-professionals.be



Proud winners of the KNX Belgium Awards.



KNX Professionals Germany in Cannes.

KNX Professionals Germany meets IoT in France

GERMANY KNX Professionals Germany were invited to visit Cannes in France. The trip was also used by various manufacturers from the fields of KNX/IoT to present applications such as multiroom audio, voice control, KNX IP video door intercom systems, and much more. Participants also had the opportunity for a lively exchange in a charming atmosphere.

Contact: Dirk Müller | info@knx-professionals.de
www.knx-professionals.de

KNX Usergroup Hong Kong Reaches Further

HONG KONG With the support of TÜV Rheinland, which offered its premises for the event, and the members HDL and Suffice, KNX Userclub Hong Kong organised a great event for participants from the fields of system integration, manufacturing and specifying. Events such as this help pave the way to making KNX even more popular and accessible.

Contact: John Lau | john_lau@suffice.com.hk



High expectations of visitors prior to the event.



Roosbeh Bitra presents KNX.

KNX Smart City & Smart Grid Workshop in Iran

IRAN KNX Userclub Iran successfully organised the KNX Smart City & Smart Grid Workshop. This highlighted the many opportunities and possibilities of KNX thanks to its openness, and helped to demonstrate, once again, how KNX is ideally suited to a wide range of applications worldwide. Besides the many benefits of KNX technology, the fact that KNX has finally arrived in Iran has generated great interest.

Contact: *Roosbeh Bitra | roosbeh2004@gmail.com*

KNX Exhibition and Technical Seminar in Beirut

LEBANON The Order of Engineers & Architects of Lebanon hosted a KNX exhibition and technical seminar in Beirut. Organised by the KNX Userclub Lebanon, the seminars covered a wide selection of topics including the future of home and building control, whilst the exhibition was furnished with KNX panels on which local distributors displayed a large selection of KNX devices and solutions.

Contact: *Hrayr Dantziguian
knx-userclub-lebanon@sodetel.net.lb*



KNX Userclub Lebanon's event in Beirut.



Award winners for KNX skills in Malaysia.

KNX Userclub Malaysia Promotes Training

MALAYSIA Another milestone for KNX Userclub Malaysia was reached with the signing of the memorandum of training cooperation with the vocational college, Kolej Vokasional Sultan Abdul Samad. This will bring KNX skills to the trainers and students of this governmental institution, with the result that KNX will be included in the Electrical Installation module, and KNX devices will be supported during national and international skills competitions.

Contact: *PW Siew | pw_siew@yahoo.com
www.knx.org*

KNX Professionals Netherlands Share Knowledge at Symposium

NETHERLANDS KNX Professionals Netherlands took part in the Smart Homes & Intelligent Buildings Symposium. Participants had the chance to share their knowledge and learn about the latest updates for smart homes and intelligent buildings. KNX Professionals Netherlands also gave a presentation about KNX and the Internet of Things during the event.

Contact: *Ineke van Erp | info@knx.nl
www.knx-professionals.nl*



The KNX stand at the Smart Homes & Intelligent Buildings Symposium.



KNX PlugFest participants.

KNX Userclub Russia Organises KNX PlugFest

RUSSIA KNX Userclub Russia, CIS and Baltic, KNX National Group Russia, the Moscow State University of Civil Engineering and Messe Frankfurt RUS organised the Summer KNX PlugFest. Almost 200 professionals attended the event, which was supported by various members. The event proved a great success, highlighted by the positive feedback it generated and the increase in the number of participants.

Contact: *Dmitry Sass | dmitry.sass@knx-user-club.ru
www.knx-user-club.ru*

“Best KNX Installation in the Balearics” Competition

SPAIN As part of the Smart Technology Forum, KNX Spain organised a competition specifically for local integrators and installers in the Balearic Islands. Awards were given for the best KNX installations in both the residential and commercial sectors. The overall winner was Siadom Instalaciones, which installed extensive KNX automation in the cathedral in Palma de Mallorca.

Contact: *Michael Sartor | michael.sartor@knx.es
www.knx-professionals.es*



Proud winners of KNX Spain Awards.



Successful conference in Gnosjö

KNX Professionals Sweden Conference at Garo AB

SWEDEN KNX Professionals Sweden arranged a conference meeting at Garo AB premises in Gnosjö, Sweden. The wide-ranging agenda focused on many important topics, such as ETS Inside and the upcoming ETS Professional 5.6, as well as new documentation for various applications using KNX. The event was a major success thanks to the support of enthusiastic KNX members.

Contact: *Jan Hammersköld | info@knx.se
www.knx.se*



Alexander Maier GmbH

Germany

alexander.maier@maier-gst.de

www.busbaer.de



ARCHIMEDIA

Home Entertainment Solutions

Archimedia Lebanon

Lebanon

salah_kabouni@yahoo.com

www.exhibit-h.com



ASSOCIACIÓ
D'INSTAL·LADORS
EMPRESARIS
DE BALEARS

ASINEM

Spain

knx@asinem.net

www.asinem.net



BNJ

Iran

BNJ.ENG@gmail.com

www.BNJ.ir



Den jydsk Haandværkerskole

Denmark

knx@djhhadsten.dk

www.djhhadsten.dk

Life Is On



Ecole des Métiers de l'Énergie – Paul-Louis Merlin

France

dbizart@gmail.com

[www.schneider-electric.fr/fr/about-us/
ecole-metiers-energie](http://www.schneider-electric.fr/fr/about-us/ecole-metiers-energie)



BILDUNGSZENTRUM DER HANDWERKSKAMMER

Handwerkskammer

Osnabrück-Emsland-Grafschaft Bentheim

Germany

r.klostermann@hwk-osnabrueck.de

www.btz-osnabrueck.de



Herningsholm Erhvervsskole

Denmark

kft@herningsholm.dk

www.herningsholm.dk



KALAYTEK

Morocco

info@kalaytek.com

www.kalaytek.com



Madoc Integration Solution Sdn. Bhd.

Malaysia

muzamil89mahmud@gmail.com

www.madoc.com.my



MYSMARTHOME

Spain

mvillalobos@mysmarthome.es

www.mysmarthome.es

Life Is On



Schneider Electric Argentina S.A.

Argentina

marc.gusta@schneider-electric.com

www.schneider-electric.com

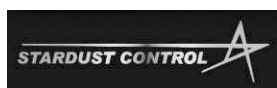

Stardust Control Co.,Ltd.

Thailand

bodin.kosakanun@hotmail.com



**Syndesmos Adeiouchon Ergolipton
Ilektrologon Kyprou**

Cyprus

seintelsol@gmail.com

T.M.K.S Consulting Engineers



T.M.K.S.

Iran

mrmvahid@yahoo.com



More information

Visit our website: www.knx.org



New Scientific Partners



APOLLON
Hochschule

APOLLON Hochschule

Germany

kurt.becker@apollon-hochschule.de
www.apollon-hochschule.de



UNIVERSITY
OF THE AEGEAN

Department of Information and Communication Systems Engineering

University of the Aegean

Greece

nangelis@aegean.gr
www.icsd.aegean.gr/icsd/



**TECHNISCHE
UNIVERSITÄT
DRESDEN**

Technische Universität Dresden

Germany

Klaus.Kabitzsch@tu-dresden.de
www.tud.de/inf/tis



More information

Visit our website: www.knx.org



User Name
KNX Login (e.g., KNX000000)

Password
Password (The ...)

Kotikansio
Opintokerrat
Otsu tilante

Tervetuloa KNX ETSS eCampukselle

KNX ETSS eCampus on verkkopohjainen koulutus, joka auttaa sinua pääsemään alkuun KNX:n peruskäsitteisiin, vaikka et ole aiemmin perehtynyt tähän teknologiaan. Lisäksi opit kuinka määritellät ja työskentelet uudella ETSS:llä.

ETSS eCampus Ominaisuudet

- Kolme lukua (ETS perusteet, ETSS Asetukset ja työskentely ETSS:llä), "askel askeleelta" -opintokerrat
- Videokoulutus
- Täydellinen "askel askeleelta" simulaatio alkuperäisellä ETSS:llä
- Kokonaisarvio Oppimistilanteesta, joka kasvaa jokaisen täydellisen opintokerran jälkeen
- ETSS eCampus Todistus – 85 % vähimmäisoppimisäärä vaaditaan
- Onnistuessaasi saat voimassa olevan etusetelin ETS Lite lisenssin ja voimassa olevan etusetelin päivitykseen ETS Litesta ETS Professionaliin



ETS eCampus available in 16 languages

KNX as topic of
between Greece
As part of an E
the Luxembourg
the 1st Athens
student excha
teachers to Lab
programme wa
management w
recent environ
participation at
CNFPC, the Gre
further interc
the KNX Basic
participants, K
organised an i
visits of KNX p
Museum of Com
controlled by
headquarter of
of the biggest R
Jul 23, 2015 1:33:57 PM

Since its contents have been updated to ETS5, the ETS eCampus has once again proven a great success. Thousands of new users have joined this free online training, making it at the same time a unique community of ETS5 students. The tool is available in Chinese, Czech, Danish, Dutch, English, Finnish, French, German, Greek, Italian, Japanese, Portuguese, Russian, Spanish, Swedish and Turkish.

<http://ecampus.knx.org>

The French National KNX journal is available

The French National KNX Journal is available

KNX at International Conferences and Fairs



KNX France Spreads Word on KNX Training

FRANCE Supported by various KNX Member companies, KNX France organised an event in Marseille at which more than 100 people gathered to learn about the various possibilities of KNX training that is available from schools, workshops, and certified KNX training centres. Participants also learned about the benefits and opportunities that come with such training.

Contact: www.knx.org

Participants in the KNX France event in Marseille.

KNX Roadshow Celebrates First Event in Shenzhen

CHINA With the support of KNX China, the KNX Roadshow made its debut in Shenzhen, a progressive city characterised by rapid development. Although Shenzhen is less than 40 years old, it has seen a remarkable amount of development, so it comes as no surprise that KNX had to be here to explain the many advantages of KNX from which the whole city can benefit.

Contact: www.knx.org

Jack He of HDL presents reference KNX projects.



KNX Chosen by Iranian Ministry of Education

IRAN With smart home and building solutions in mind, the Iranian Ministry for Education made the decision to include KNX in its teaching documentation. The decision to go for KNX was not only due to the unprecedented growth of KNX in Iran, but to the openness of KNX, which makes it the most sustainable technology.

Contact: www.knx.org

KNX lecture in Iran.

KNX Association Reaches New Markets in China

CHINA KNX Association was invited as a guest speaker at the 1st China Home Industry Internet & Intelligent Technology Conference, organised by the China Furniture and Decoration Chamber of Commerce. The event, which took place in the impressive National Exhibition and Convention Centre in Shanghai, aimed to bring technical knowledge to the companies involved in the home and hospitality industry.

Contact: www.knx.org

The KNX presentation during the conference.



Conference Week in Munich

GERMANY KNX Association participated in two conferences in Munich on September 13 and 14 respectively. At the former, KNX Secure was presented at the Smart Home Congress. At the latter, KNX Association President, Franz Kammerl, presented KNX as a new Liaison member at the Thread IoT Stakeholder Summit meeting, whilst KNX Association CTO and CFO, Joost Demarest, explained the state of the KNX IoT project at the concurrent Thread Technology Workshop.

Contact: www.knx.org

Joost Demarest at the Smart Home Conference.



KNX Tools Workshop

GERMANY KNX manufacturers were invited to a two-day KNX tools workshop at the Insta GmbH premises in Lüdenscheid, Germany. This included news about KNX tools, and also offered the opportunity to test the pre-release version of the Manufacturer Tool 5.6. It is now possible to integrate more graphical elements and visual effects in a simplified way, for even easier configuration of KNX installations via ETS.

Contact: www.knx.org

Manufacturers at the KNX tools workshop.



Training Centre Conference

FINLAND The 2017 conference for KNX-certified training centres took place at the Prakticum training centre in Helsinki, September 25–26. More than 70 KNX training centre representatives enjoyed fascinating presentations and the opportunity to brainstorm on how KNX Association could reshape the future of KNX training.

Contact: www.knx.org

The attendees of the successful Training Centre Conference.



HiTech 2017 in Moscow Welcomes KNX

RUSSIA KNX was the centre of attention at the 2017 edition of HiTech in Moscow, held from 31 October to 2 November. With an impressive stand and the support of six co-exhibitors, KNX Russia demonstrated how KNX is the control technology for the world. This message was further endorsed by the KNX Association at the opening ceremony of the show, as well as in the concurrent KNX Forum. **Contact:** www.knx.org

The KNX stand at HiTech in Russia.



KNX Association at European Smart Homes 2017

U. K. The two-day European Smart Homes 2017 conference in London saw KNX Association CTO and CFO, Joost Demarest, present a wide range of benefits that KNX offers. One of the highlights was his presentation of ETS Inside as “everybody’s solution” for smart homes, and Joost Demarest made it clear, during a panel discussion, why KNX is the perfect platform globally for integrated smart home solutions. **Contact:** www.knx.org

Joost Demarest at European Smart Homes 2017.

KNX Informs Hospitality Sector in Czech Republic

CZECH REPUBLIC KNX Association was again invited to the HTNG (Hotel Technology Next Generation) Europe event in Prague. The goal of the HTNG association is to inform the hospitality industry about new technological trends. Together with representatives from Z-Wave and Thread, KNX was part of a podium discussion on the topic of IoT and security.

Contact: www.knx.org

HTNG Europe event in Prague.

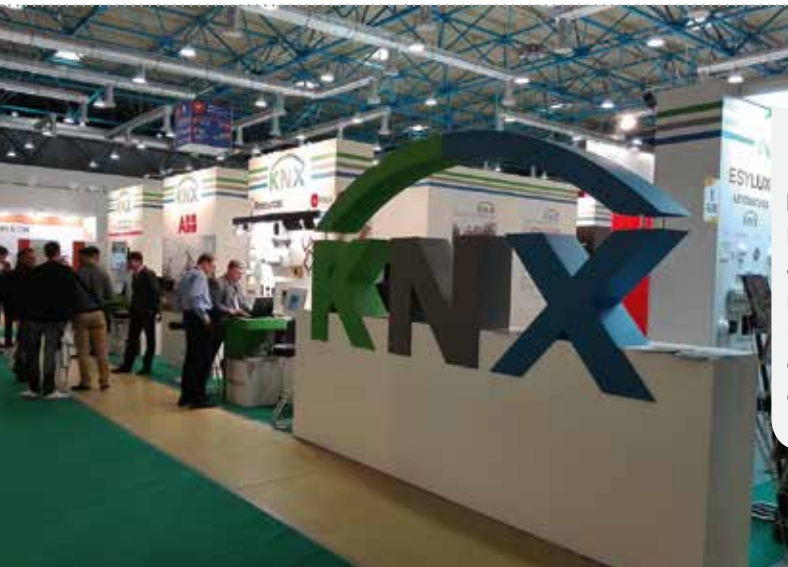

KNX at Interlight Russia

RUSSIA In cooperation with international KNX Members, KNX Russia organised an impressive presence at the Interlight 2017 show in Moscow. Thanks to the many KNX solutions, products and other highlights, KNX Russia was again the centre of attention at one of the country’s major trade shows. Indeed this event concluded the most successful year so far for KNX Russia. **Contact:** www.knx.org

KNX stand at Interlight.

KNX Expands Training Opportunities in Japan

JAPAN In conjunction with KNX Japan, KNX Association organised a four-day KNX crash course for two companies interested in offering KNX certified courses in Japan. Four people attended from the engineering company Chiyoda-Keizo, and one from the installation company Kyudenko. Both companies are now delighted to have at least one KNX-certified tutor, which is one of the prerequisites to offering KNX-certified courses. **Contact:** www.knx.org

Trainees in the presence of their KNX tutor, KNX Association CTO and CFO, Joost Demarest.



Smart Home Initiative Invites KNX to Security Conference

GERMANY KNX Association was invited to a conference on security that was organised by the Smart Home Initiative Deutschland. With KNX Secure, it is now possible to prevent eavesdropping during device configuration and during runtime. KNX Secure is based on international standardised algorithms and is a standard in its own right. KNX Association was keen to stress that “classic” KNX installations can also be made secure. **Contact:** www.knx.org

Audience at the Smart Home Security Conference.



KNX Grows in Thailand

THAILAND Thanks to highly-popular KNX events in Thailand, including a forum and a fair with a concurrent seminar, it comes as no surprise that the KNX Association has decided to extend its activities in the country. The successful premiere of KNX at the Thailand Building Fair 2017 in the BITEC exhibition centre in Bangkok, served as a focus for the local KNX community and saw the first steps in the foundation of the 45th KNX National Group – KNX Thailand!

Contact: www.knx.org

The KNX Seminar in Thailand.



KNX books now available as ebooks.

Until now, the KNX books were only available in paper format. Due to the number of smartphones and tablets used worldwide, KNX Association offers now most of its books in ebook format like KNX Handbook, Basic Course and Advanced Course. The ebooks are available via the Amazon website. If you want to see a list of the KNX books, have a look on this link: <http://my.knx.org>



Handbook for
Home and Building Control
Basic Principles

Events and Fairs Schedule

light+building

Light + Building 2018

18. - 23. 3. 2018

Frankfurt (Germany)

The world's leading trade fair for lighting and building services technology.

www.light-building.messefrankfurt.com/frankfurt/en/aussteller/willkommen.html



Nordbygg

10. - 13. 4. 2018

Stockholm (Sweden)

HVAC and Construction fair

www.nordbygg.se/?sc_lang=en



Lightfair International 2018

8. - 10. 5. 2018

Chicago (United States)

The world's largest annual architectural and commercial lighting trade show and conference.

www.lightfair.com



EL & Teknik 2018

15. - 17. 5. 2018

Odense (Denmark)

The largest electro-technical trade fair in Denmark.

www.elogteknikmessen.dk



Tektonica

16. - 19. 5. 2018

Lissabon (Portugal)

The Largest Portuguese Building and Construction Fair.

www.tektonica.fil.pt



Eliaden 2018

29. - 31. 5. 2018

Lillestrom (Norway)

The industrial event where the entire electrical engineering industry will meet up.

www.eliaden.no



Integrate 2018

22. - 24. 8. 2018

Sydney (Australia)

Australia's premier annual AV and Integration trade show.

www.integrate-expo.com



IFA

31. 8. - 5. 9. 2018

Berlin (Germany)

Fair for consumer electronics and home appliances.

www.b2b.ifa-berlin.com



Energetab 2018

11. - 13. 9. 2018

Bielsko-Biala (Poland)

The largest energy fair in Central Europe.

www.energetab.com



Facilities Integrate 2018

25. - 26. 9. 2016

Auckland (New Zealand)

Facilities Integrate gathers all the major players in the building industry.

www.facilitiesintegrate.nz



Euroskills 2018

26. - 28. 9. 2018

Budapest (Hungary)

European Championship of young professionals of skills.

www.euroskills2018.com



Light India 2018

11. - 13. 10. 2018

New Dehli (India)

Lighting industry fair in India.

www.light-india.in.messefrankfurt.com/newdelhi/en/exhibitors/welcome.html



KNX Training Centre Conference

15. – 16. 10. 2018

St. Pölten (Austria)

Two-day conference for KNX Certified Training Centres
www.knx.org



Elmässan

17. – 18. 10. 2018

Stockholm (Sweden)

Electrical fair in Sweden.
www.easyfairs.com/sv/elmaessan-stockholm-2018/
elmaessan-stockholm-2018



KNX Scientific Conference

18. – 19. 10. 2018

Vienna (Austria)

Conference to encourage co-operation between universities and/or technical institutes and the KNX industry.
www.knx.org



HI-TECH Building

24. – 26. 10. 2018

Moscow (Russia)

The most important annual event for home and building automation in Russia and the CIS.
www.en.hitechbuilding.ru



belektro

6. – 8. 11. 2018

Berlin (Germany)

Trade Fair for electronics and lighting.
www.belektro.de/en



Interlight 2018

6. – 9. 11. 2018

Moscow (Russia)

International Trade Fair for Decorative and Technical Lighting, Electrical Engineering, Home and Building Automation.
www.interlight-moscow.ru
messefrankfurt.com/moscow/en/exhibitors/welcome.html



Matelec 2018

13. – 16. 11. 2018

Madrid (Spain)

International Trade Fair for the Electrical and Electronics Industry.
www.ifema.es/matelec_06



GET Nord

22. – 24. 11. 2018

Hamburg (Germany)

Trade fair for Electronics, Sanitation and HVAC
www.get-nord.de/en

Imprint

KNX Journal International

The KNX Journal is the international magazine for home and building control based on KNX technology. Experts, practitioners and professionals show the way in applying and developing the KNX standard – from home and building control trends to devices and application projects; from the KNX members and partners to useful information on event stands and publications. Special attention is given to members and activities of the KNX Association International and their national groups.

Distribution

This annual and bilingual Journal (English/German) can be ordered free of charge by all members, partners (installers, scientific, training centres, associated, national groups) and by media representatives of KNX Association International. Order the KNX Journal by email from knx-journal@knx.org.

Online Distribution

The KNX Journal International is posted as a Portable Document Format (PDF) file to www.knx.org/news-press/knx-journal/.

Editor

KNX Association cvba
De Kleetlan 5 Bus 11
B-1831 Diegem - Brussels, Belgium
Phone: +32 (0) 2 775 85 90
Fax: +32 (0) 2 675 50 28
Email: info@knx.org
URL: www.knx.org

Editorial Office

Redaktion KNX Journal
Friedrich-Wolf-Str. 16 A
12527 Berlin
Germany
Phone: +49 (0) 30 64 32 62 79
Fax: +49 (0) 30 64 32 62 78
Email: knx-journal@knx.org
URL: www.knx.org/news-press/knx-journal

ISSN

2033-7396

Print edition

80,000 copies

Picture credits

KNX Association cvba, editorial office and specified companies

Copyright

Reproduction of contributions only with permission of the publishing house under detailed source data. The publishing house does not take any responsibility for unsolicited manuscripts and entries.

The photos are provided by the respective companies. Brands used in this magazine without guarantee that they may be freely employed. Texts, illustrations and technical data are carefully compiled, nevertheless errors cannot be completely excluded. The publishing house and the authors assume no legal responsibility or liability for incorrect data.

KNX® and ETS® are registered trademarks of KNX Association cvba, Belgium.

YOUR PARTNERS



Heinz Lux
CEO

✉ heinz.lux@knx.org
☎ +32 (0)2 775 85 90



Joost Demarest
CFO, CTO

✉ joost.demarest@knx.org
☎ +32 (0)2 775 86 44



KNX ASSOCIATION

De Kleetlaan 5
B - 1831 Diegem-Brussels
Belgium

CONTACT

Phone: +32 (0)2 775 85 90
Fax: +32 (0)2 675 50 28
Email: info@knx.org
Web: www.knx.org

Sales



Serge Creola
Sales & Support Manager

✉ serge.creola@knx.org
☎ +32 (0)2 775 85 90



Ulrike Eggers
Sales & Administration

✉ ulrike.eggers@knx.org
☎ +32 (0)2 775 85 90



Tanja Kiewitz
Sales

✉ tanja.kiewitz@knx.org
☎ +32 (0)2 775 85 90

Follow us: 



Marketing



Casto Canavate
Marketing Manager

✉ casto.canavate@knx.org
☎ +32 (0)2 775 85 91



Thibaut Hox
Marketing

✉ thibaut.hox@knx.org
☎ +32 (0)2 775 85 99



Christian Stahn
Marketing

✉ christian.stahn@knx.org
☎ +32 (0)2 775 86 48



Ufuk Unal
Certification Manager

✉ ufuk.unal@knx.org
☎ +32 (0)2 775 86 53

System & Tool



André Hänel
System & Tool Manager

✉ andre.haenel@knx.org
☎ +32 (0)2 775 85 90



Steven de Bruyne
System Architect

✉ steven.debruyne@knx.org
☎ +32 (0)2 775 86 47



Vassilios Lourdas
System & Tool Engineer

✉ vassilios.lourdas@knx.org
☎ +32 (0)2 775 86 40



Jesús Arias
Members & Solutions

✉ jesus.arias@knx.org
☎ +32 (0)2 775 85 90



Christophe Parthoens
System Engineer

✉ christophe.parthoens@knx.org
☎ +32 (0)2 775 86 49



Dries Verbrugge
KNX IoT Architect

✉ dries.verbrugge@knx.org
☎ +32 (0)2 775 86 58



SALES

KNX Tools Online Shop
<https://my.knx.org>



TOOL SUPPORT

KNX Help Centre
<https://support.knx.org>



One Standard (ISO/IEC 14543)

One Tool (ETS)

Smart home and building solutions.
Global. Secure. Connected.

All Media:

- Ethernet (IP)
- Twisted Pair (TP)
- Radio Frequency (RF)
- Powerline (PL)

420 KNX
Manufacturers



in 44 Countries
7,000 KNX Certified Products

+74,000 KNX
Partners



in 190 Countries

440 KNX
Training Centres



in 68 Countries

14 Test Labs



17 Associated
Partners



45 KNX
National Groups



140 KNX
Scientific Partners



in 33 Countries

21 KNX
Userclubs / Professionals



in 19 Countries





KNX MEMBERS | 420 Manufacturers from 44 Countries



Smart home and building solutions.
Global. Secure. Connected.

