



JOURNAL

Fujitsu became KNX
Member No 300

KNX city Solutions

KNX is arrived
in Australia

New ETS App:
Online Product
Catalog



1
2013

The worldwide **STANDARD**
for home and building control

www.knx.org

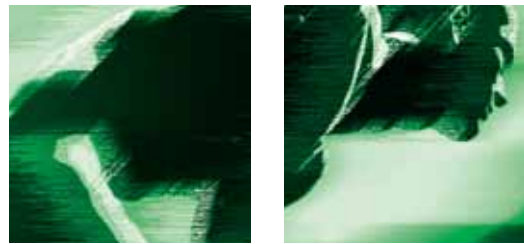
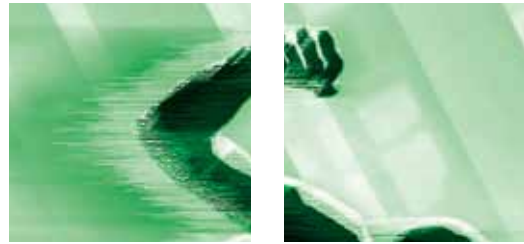

www.knx.org

- Easy
- Fast
- Open

ETS4 Professional

NEW ETS Apps NEW

New licenses	PC dependent Host-ID	PC independent Dongle	Restrictions
ETS4 Professional	900,00 €	960,00 €	
ETS4 Supplementary	50,00 €	110,00 €	For Notebooks, max. 2 licenses, only together with ETS4 Professional
ETS4 Lite	100,00 €	160,00 €	max. 20 products
ETS Apps	see KNX Online Shop	see KNX Online Shop	
Upgrade licenses			
ETS3 Pro > ETS4 Pro	250,00 €	310,00 €	
ETS3 Supplementary > ETS4 Supplementary	50,00 €	110,00 €	
ETS3 Trainee > ETS4 Lite	50,00 €	110,00 €	
Educational licenses			
ETS4 Training Package	1.000,00 €	1.500,00 €	1 x ETS4 Professional, 10 x ETS4 Lite / 2 x Trainingshandbook

All prices: + VAT; + Service fee (15,- € / order)

<http://onlineshop.knx.org>

Editorial



Heinz Lux,
CEO, Spokesman
KNX Association

Smart KNX city

The complexity theory deals with problems that can be described by means of mathematical models. Complex systems are systems that defy simplification, remain multi-layered but are able to adjust to changes. An example is the intelligent power grid ("smart grid"). Numerous technicians and engineers are currently trying to make systems related to traffic control, industrial automation and building automation (including heating, cooling, lighting, security, comfort and household appliances) energy efficient. One can save the most energy by using energy efficiently. Since the use of classic light bulbs has been restricted in the EU, nearly all households are equipped with energy saving lamps. However, often these are separate solutions. Island approaches are successful. Is that smart?

On top of that, there is an increase in the use of renewable energy sources like wind and solar energy, which are fed into the middle and low voltage grid. There is moreover a tighter integration of the consum-

er as client and producer of energy, since only what is measurable by e.g. smart metering, one can also truly influence.

This makes it clear that future systems will face further challenges that go beyond buildings or separate actions, but need to be considered and realized as part of a bigger picture, converting the entire grid to a smart grid, only possible with the help of smart metering and smart buildings. Everything is smart, but is it intelligent?

More intelligent is the linking of the electrical components of different application control areas, such as Lighting, Heating, Ventilation and Air-conditioning via a smart Building Management System. KNX is the standard that can ensure this.

Energy saving and efficiency without intelligent building services engineering remains patchwork. Intelligence of the grid or buildings without KNX does not work. KNX City is not only smart, but it is also intelligent and clever. And only in this way a complex system becomes very simple: KNX.

Editorial

- 2 Fujitsu General joins as KNX member No. 300!

KNX city solutions

- 3 The interaction between KNX and the intelligent power grid (smart grid)
- 4 KNX city – the solutions

KNX has arrived in Australia

- 8 KNX in the land "down under"
- 9 Australia's first KNX certified training centre opens at RMIT University
- 10 Six green stars for KNX System
- 11 KNX Controls Western Australian Football & Rugby
- 12 Monash University New Horizons
- 13 Using KNX to enhance industrial applications
- 14 Cameron Australasia

KNX Tools

- 15 New: the ETS App – Online KNX Product Catalog!
- 16 New ETS Apps

KNX Members

- 17 New Members
- 21 New Products

KNX Partner

- 35 National Groups
- 48 KNX Training Centres
- 51 KNX Scientific Partners
- 54 KNX Userclub / KNX Professionals

KNX Out & About

- 56 KNX at international Conferences and Fairs
- 61 Imprint

Fujitsu General joins as KNX member No. 300!

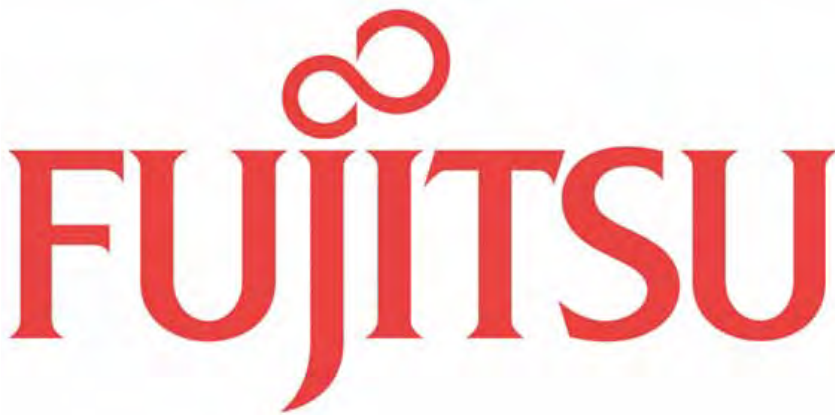

The interest in the KNX system, the worldwide standard for home and building control, enshrined in the ISO/IEC 14543-3 series, continues to grow. The community around this technology, known for its high degree of interoperability between products of different manufacturers and different application domains, was recently proud to welcome the 300th manufacturer joining its ranks, Fujitsu General from Japan.

Fujitsu General Limited with its headquarters in Kawasaki (Japan) was established more than 75 years ago and has become a world-wide leader as a manufacturer of air-conditioners and electronic devices and as a provider of IT related system products and services. Fujitsu General has over 30 subsidiaries around the world and in 2011 achieved a global turnover of 200,000 million yen. The interest of Fujitsu General lies in enriching the KNX product portfolio with KNX interfaces to its air-conditioners, which will undoubtedly greatly



Picture 1. Satoshi Tomioka, General Manager of the VRF Development Division at Fujitsu General



Picture 2. Stephan Bauer, Siemens AG, President of the KNX Association

benefit to the further application of the KNX even into this area of building control.

Stephan Bauer, President of the KNX Association, commented: 'The interna-

About Fujitsu General Limited

Fujitsu General Limited, established in 1936 is a world-wide manufacturer of air-conditioners, electronic devices and a provider of IT related system products and services. The headquarters are located in Kawasaki, Japan. Their main product gamma are air conditioners; with product lines ranging from room air conditioners, multi type system to VRF system for buildings as well as air to water appliances. In the fiscal year of 2011 fiscal Fujitsu sold products to customers worldwide for about 200,000 million yen. It has over 30 subsidiaries around the world, including factories. Fujitsu General is a member company of the Fujitsu group, headed by Fujitsu Limited, a Japanese IT giant, who does not own the company, but is a major shareholder of Fujitsu General.

Contact: www.fujitsu-general.com

tionalization of the KNX system was a prime goal set by the KNX Executive Board back in 2009: at that time, the influence of the KNX system was pretty much confined to the European borders. The application for membership of more than 100 new members in 33 countries in the past two years clearly underpins the spreading of the KNX system into other parts of the world, i.e. Latin America, South-Africa, Middle East, but first and foremost Asia, where Fujitsu General is already the third Japanese company to join KNX, after Daikin and Panasonic'.

Satoshi Tomioka, General Manager of the VRF Development Division at Fujitsu General confirms: 'KNX has an ever growing international presence, where more and more building designers require companies to deliver solutions that are compatible to the ISO/IEC 14543-3 standard. In this respect, Fujitsu General hopes to couple its expertise in air-conditioning with those of KNX in home and building control'.

Contact: www.knx.org

Evolution KNX members 2002 – 2012

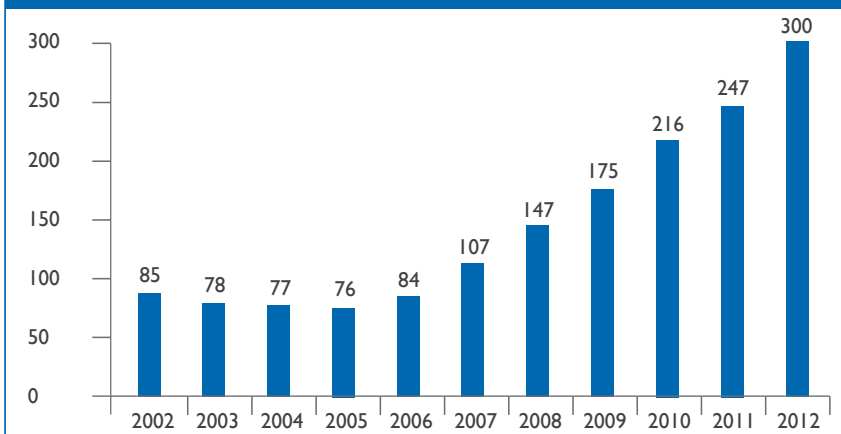

The interaction between KNX and the intelligent power grid (smart grid)



KNX city represents innovative solutions, meaning future sacrifices in comfort or electricity prices will not have to be feared, despite the use of renewable energy. For this, in addition to the individual KNX building solutions, it is also important to highlight the superordinate power grids or the superordinate city and their energy management. In the KNX City, KNX interacts with the intelligent power network (smart grid). The following section presents five scenarios of a nested daily routine in the city of the future. Potential problems in the city are explained and the city's response based on KNX is given.

Scenario A: Excess renewable energy

The network load in the city at night reaches its lowest level while at a time ample renewable energy is fed into the grid because of strong winds. This excess power should be used by the city. In or-

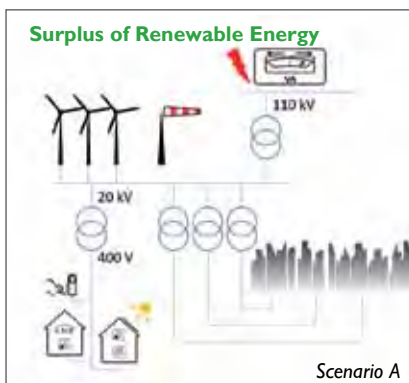

der to do this, the excess is signalled to intelligent homes and apartments in the city by means of communication technology. They can then switch on loads connected via KNX such as domestic appliances and electric vehicles. In this way, the energy supply is balanced out by means of KNX.

Scenario B: Insufficient renewable energy

This problem can be seen as complementary to Scenario A. By way of example, KNX city demonstrates the diminishing feed-in from the wind-powered generators during the morning hours (stagnation). The city shall respond by shedding some load, which is possible by means of

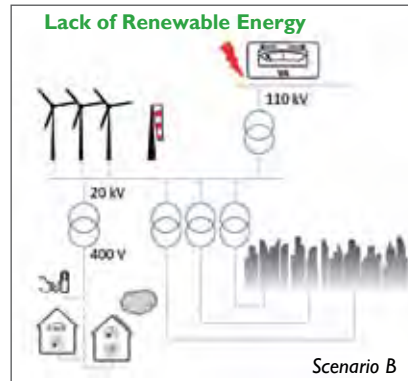

KNX. The charging stations for electric vehicles are deactivated, domestic appliances are switched off and air conditioning units or heat pumps are set into Eco-mode. In this way, the energy supply is thus balanced out by means of KNX, without grid outage.

Scenario C: Peak load over the entire city

Grid load is highest, particularly during the evening hours when city residents return home. Peak loads are experienced in the household sector due to cooking, light usage in the evening hours, consumer electronics, domestic appliances and electric vehicles. This situation is further aggravated by the service industries and local public transport, so that bottlenecks can occur even during periods of normal or high feed-in from renewable energy sources. By means of KNX, connected loads can be reduced as already shown in Scenario B. An additional option would be to feed energy stored in vehicle batteries in electric cars back into the grid in order to make additional energy available. KNX not only helps to relieve the city's grid in this way, but provides support for it as well.

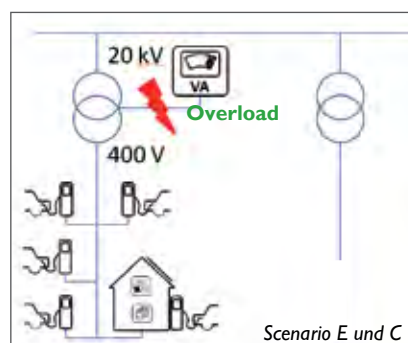

Scenario D: Local voltage rise

Photovoltaic systems installed on rooftops and facades in the city feed the energy generated into the low-voltage network. At times, particularly around noon, this can lead to a situation in a network segment where virtually no energy is taken from the higher voltage levels. In extreme cases, the low-voltage network even feeds energy back into the medium-voltage level. As a rule, the low-voltage network is not configured for this type of energy flow, which can result in unacceptable voltage increases. An intelligent energy supply with Smart Homes and Smart Apartments can work to counteract this problem by increasing the load on a local basis. For this to take place, the loads connected to KNX shall be switched on or increased. Domestic appliances and

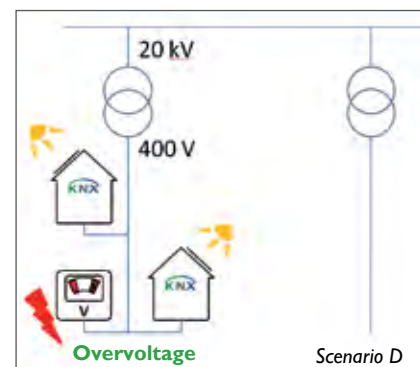

electric vehicles can be switched on and air conditioning systems or heat pumps can be set to a comfort mode. KNX then helps to prevent a downward regulating of the photovoltaic feed-in.

Scenario E: Local transformer overloading

As already discussed in Scenario C, the highest network loading takes place during the evening hours. Before a situation similar to Scenario C arises, however, partial network overloading can already occur before that. This is typically transformer overloading, which might result when numerous electric vehicles are being charged at the same time. The vehicle charging process can be interrupted by means of KNX, alleviating the overload and preventing a local power outage.

KNX city – the solutions



ELECTROMOBILITY

Task

The limited availability of oil, coupled with the increasing demand for it on the world markets have resulted in continuously rising oil prices over the past years. For this reason, hopes in the sector of individual mobility have been placed in electromobility to ensure independence from oil. For the supply of electrical energy to the city, however, electromobility means an increase in the consumption of electricity. Furthermore, the peak e-mobility loads are expected to be during the evening hours, when people return home from work and their cars are hooked up for recharging during the night-time hours. These peak loads overlap with the then private household peak loads and consequently present a risk to the safe supply of energy. On the one hand it can lead to local transformer overloads, and on the other hand additional generating capacity is required.

Solution

While the expected overnight time for a parked electric vehicle is about 10 hours, the required charge time of three to five hours is significantly less. The charging process can in principle be shifted to the night-time or to the early morning hours, and would considerably relieve the grid situation. Switching the charging process off and on can also depend on the variable electricity tariff, to shift the charging process to a time when electricity is the cheapest.

Realisation

Charging stations use a plug especially adapted to the needs of the charging process. The plugs allow latching the charging station and the vehicle to protect against disconnection and they also check whether earthing of the vehicle is guaranteed during the charging process. Hence, closure of the charging contactor is permitted only after a successful test of the safety items mentioned. Charging stations can also be extended to include KNX communication, on the one hand to report the presence of a vehicle (latched plug) to the building con-

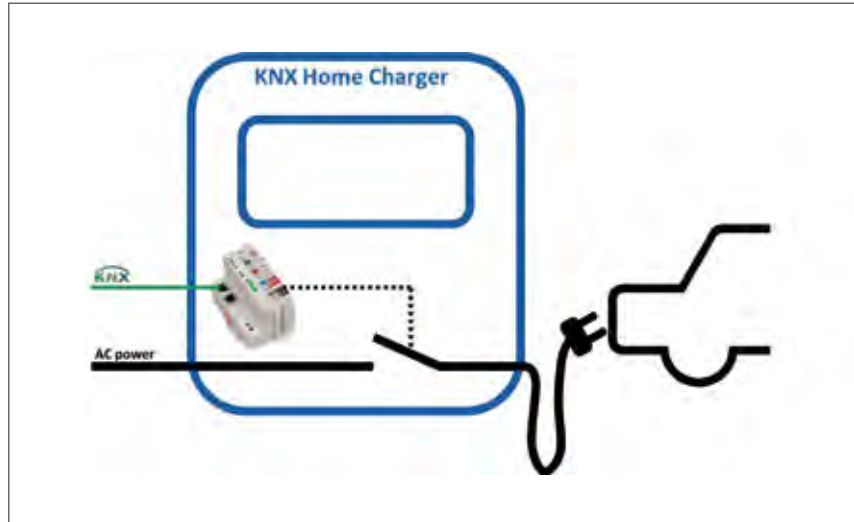

troller and, on the other hand, to enable remote starting of the charging process (closure of the charging contactor).

Function

By KNX integration of the charging station, the building controller gets control over one of the most powerful and energy-intensive loads in the household. In the event of an energy shortage, the charging contactor can be opened and the load reduced. Or, if supported by the charging station or the vehicle, energy can also be fed back into the power grid. This also facilitates the adaptation of the charging process to a variable electricity tariff. If desired, the user can also initiate the immediate charging of a vehicle via a KNX panel if, for instance, the car would be needed again soon.

Advantages

Even a small number of electric vehicles on the grid needing to be charged are enough to provoke local transformer

overloading. With the aid of the charging station connected to the Smart Home or Smart Apartment, receiving information on a pending overload situation from the Smart Grid, overload can be countered through a timely interruption of the charging process. Excess energy on the grid can also be used by then restarting the charging process.



LOAD MANAGEMENT

Task

Traditional energy supply adapts energy generation to energy demand. For this purpose, base-load, medium-load and peak-load power stations always supply the required amount of generated energy, subject to the grid frequency. The energy generation of renewable energy sources has the disadvantage that it fluctuates. Consequently, they cannot generate energy arbitrarily in the event a demand for generation arises. Thus, the traditional regulating principle does not function in the same manner for renewable energy. This can have an impact on the security of supply, in particular when furthering development of renewable energy sources and the simultaneous shutdown of conventional fossil power plants.

The solution that is currently under discussion is the smart grid. By using information and communication technology, this grid would make it possible for loads to be adapted to fluctuations in production.

The task is to realize a KNX load management, which can adapt building loads to one's own power generation rates or to a time-variable electricity tariff.

Solution

For load adaptation, KNX sensors are necessary, which measure the consumption of electricity on the one hand, as well as the potential generation from a photovoltaic system on the other. This can be ensured using KNX DIN rail meters or intelligent household meters connected to KNX. In addition to the KNX sensors, KNX switching actuators are needed to switch on/off loads or domestic appliances. KNX switching actuators can be used for normal loads. For specific loads such as domestic appliances or HVAC systems, special KNX interfaces are used that can switch the units on via the device electronic circuitry. Last but not least, a control unit is required with an appropriate "program" for load adaptation. If a time-variable tariff is transmitted to KNX, the control unit can then also adapt loads to it. KNX logic modules, KNX panels with logic functions, or a PLC coupled to KNX can be used as control unit.

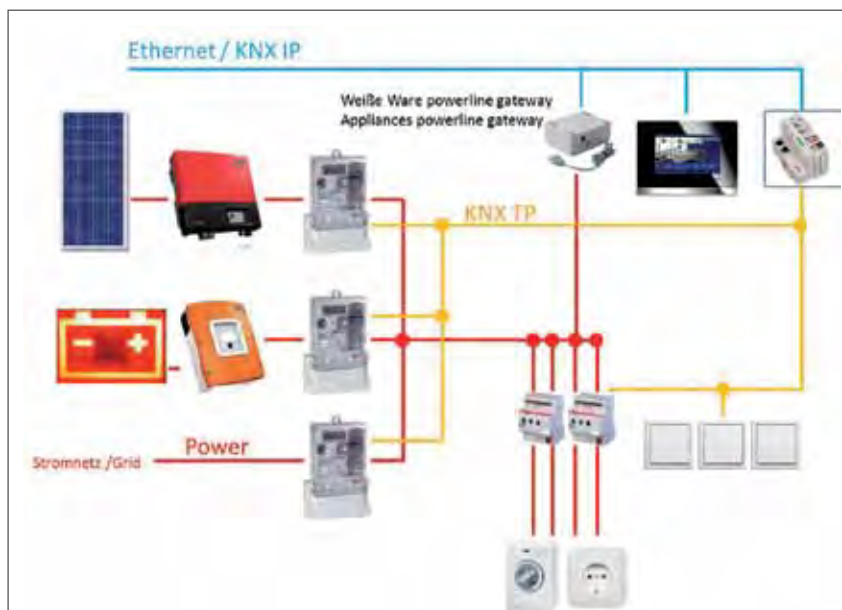

KNX Load Management: An algorithm based on KNX PLC guarantees the optimal switching of loads and white goods in relation to the present solar power system. And thanks to simultaneous energy sub metering of the KNX actuator loads, a power buffer can also be established if required.

Realisation

Sensors:

Intelligent power meters are used for superordinate measurements. KNX DIN rail meters are used for subordinate measurement of the individual consumption.

Actuators:

Conventional loads are connected via switching actuators. Energy actuators provide a solution for this, as these can also both measure as well as switch, thereby uniting the sensor and the actuator functions in one device. Household appliances are connected via Powerline and the KNX Panel. Air conditioning units are connected via the respective KNX interfaces.

Control unit:

A PLC or a Panel can be used as a control unit.

Function

- Load adaptation to one's own photovoltaic power generation
- Load adaptation to the electricity tariff

Advantages

- Thanks to KNX, household appliances can be connected via their Powerline interface. This is a far more elegant solution than simply activating the power connection.
- Cost savings through optimal exploitation of the tariff
- A high degree of automation

DISTRIBUTED PROPERTIES

Task

KNX already offers solutions today for distributed properties, where the buildings are linked up via communications technology and Internet as if they were one building. This is of particular importance for the administration of multiple buildings by building societies or for companies, whose multiple buildings are distributed throughout the city.

Solution/Realisation

KNX/IP router couple the KNX TPI line from a building to IP. If a KNX/IP router is integrated into a network that has access to the Internet, then a secured tunnelling connection can be established by means of a VPN via the Internet to other buildings with KNX/IP routers.

Function

The transmission of measured values for balancing and billing purposes is simplified by linking multiple buildings to a common KNX installation. Additionally, a central visualisation of functions is possible at one or more locations.

Advantages

Data for the accounting of consumption and feed-in values can be centrally collected. In a similar manner, property-spanning energy management can be implemented, which can be used, for example, to adjust the performance of the heating or air conditioning systems in the offices over the weekend. Systems and properties can be visualised, controlled and monitored from a remote location via the existing network or the Internet (VPN connection).

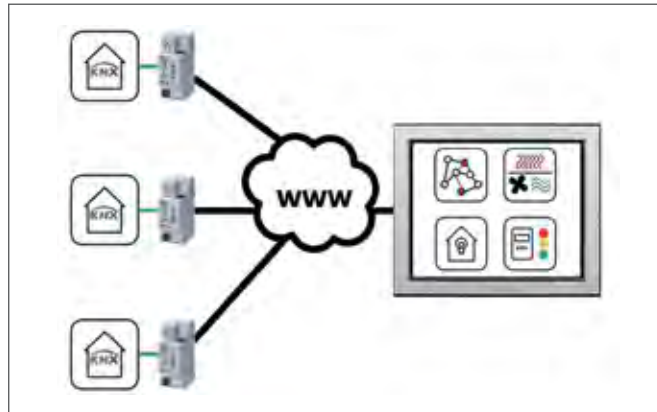

Central visualisation for distributed properties

HVAC-SYSTEMS

Task

In order to maintain a balanced energy supply during periods of peak load in the cities, loads are needed that can be temporarily reduced or switched off. Because a large portion of the required energy in cities can be attributed to the provision of air conditioning in buildings, a small change in the temperature setpoint can have a great effect on the overall supply.

Solution

The temperature set points for heat pumps and air conditioning systems are usually set by the user. A room temperature regulator compares the actual temperature measured with the target temperature and regulates the heat pump or air conditioning system accordingly. By connecting the heat pump or air conditioning system to the KNX bus, it is now possible to automatically intervene into the setpoint specification process.

Realisation

The user can store various temperature setpoints in advance in a KNX panel. For example, values can be set and stored for a comfort temperature, a standard temperature and an eco-temperature. The preferred value can in the end be transmitted to the heat pump or air conditioning system by means of a gateway (e.g. Theben, Zennio).

Function

Intervention into the room air conditioning system can be undertaken according to the utilisation capacity of the grid. For instance, the air conditioning system could be set to the "Eco" operating mode during times of high demand. In so doing, the energy required by the heat pump or air conditioning system is reduced immediately. On the contrary, in the event of weak network loading or an excess supply of regenerative electricity, the "Comfort" operating mode can be set. The network load is thus increased in favour of a higher level of living or working comfort.

Advantages

Integration of the heat pump or air conditioning system into the KNX bus



is beneficial because the building gets a variable load, with which it can respond to external signals such as network load and the price of electricity. These responses will be crucial in the future to ensure a stable energy supply, in view of the increasing proportion of renewable energy along with the increase in electric loads (e-mobility).

TARIFF MANAGEMENT

Task

Smart power meters will in future replace the conventional power meters of the energy providers. This is the prerequisite to be able to charge according time-variable electricity tariffs (which may have multiple levels in a grid section depending on renewable energy generation). This then allows to count every second the actual consumption or generation (e.g. from one's own photovoltaic system) in kilowatt hours. At the same time, these meters have a customer interface.

This tariff must be conveyed to KNX in order to enable KNX load management.

Solution

KNX offers various solutions for integrating these meters:

Energy data gateway (MUC)

Meters are read-out via a Multi Utility Communication Gateway, which transmits the meter values per IP to the KNX bus or transmits it directly via KNX RF to a display for visualization.

KNX RF interface

A KNX RF interface transmits the values directly to the KNX bus. The KNX RF signal can be converted to KNX TPI via a media coupler.

Direct KNX meter

The intelligent meter provides a direct KNX TPI interface

Realisation

The following section presents two examples of possible solutions:

Energy data gateway (MUC)

The smart power meter is connected via an energy data gateway (MUC) via KNX/IP to the Busch Comfort Panel. This provides the meter values to the KNX bus. The values can then be visualised on any KNX panel. Moreover, values can be depicted on mobile devices. Furthermore, the meter values can be used for load adaptation through KNX actuators.

KNX RF

A Hager KNX RF interface is directly attached to the smart meter, which transmits the meter values per radio to the KNX bus. These can be visualised by means of a Hager domovea unit such as the Domovea panel or any other KNX panel. Furthermore, the meter values can be used for load adaptation through KNX actuators.

Function

- Transmission of the current generated (PV) power as well as the current load to KNX
- Transmission of the energy generation and consumption to KNX
- Transmission of the tariff
- Visualisation

Advantages

- Meter value transmission is possible both wired as well as wireless
- No extra measurement sensors are required as with conventional power meters



Intelligent household meter for photovoltaic and related systems, including KNX submetering.

- Automatic KNX load adaptation is made possible
- This is beneficial for the power grids as voltage instabilities due to a large degree of photovoltaic feed-in cannot occur and generation can be collected in a tariff-controlled way thanks to the KNX load adaptation.

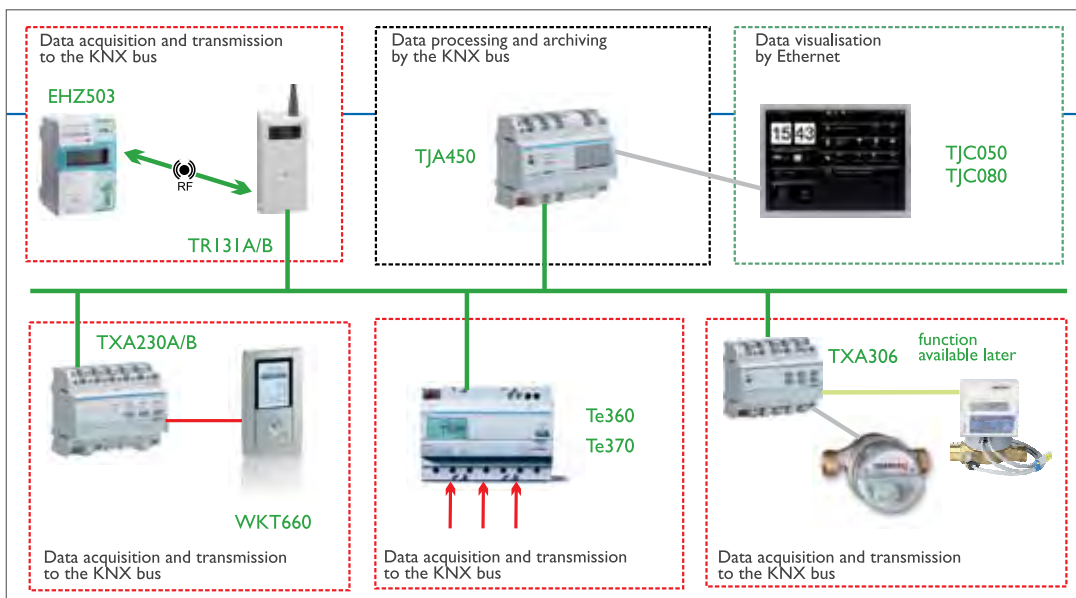



KNX in the land "down under"



Australia may seem a long way from Europe however the ties of technology overcome the perception of distance. Australians have adopted the "working smarter" philosophy in many aspects of our lives, so it is logical that KNX, the worldwide standard for home and building automation, would be embraced strongly in the island continent.

Over the years the remoteness of Australia has meant we have needed to be increasingly resourceful in finding clever solutions to applications. This translates so well into the KNX world, where the building blocks of an application are readily available to be applied to a problem and create a complete packaged solution.

In a few short years that the KNX National Group has been active in Australia we have seen a significant increase in the application of KNX to both major projects and everyday applications. The lateral thinking of the local Australian systems integrators has highlighted opportunities to utilise the open protocol of KNX to the greatest advantage on a variety of projects, providing innovative solutions embracing the energy efficiency requirements of modern design.

KNX in Australia achieved some milestones in recent years. At the 2011 World Skills Competition in London,

Benjamin Houghton of Australia won the Gold Medal in the Electrical Installation category including KNX as the preferred protocol. In 2012 an Australian project, the Surf Coast Shire Offices won the International KNX Award for best project in the Africa, America and Australia region. Further Australian projects were also highly considered in other award categories in 2012. During 2012 a further step was taken with the official opening of Australia's first Certified Training facility at RMIT University in Melbourne. RMIT (Royal Melbourne Institute of Technology) is one of the oldest technical universities in Australia and highly regarded for the innovative training that they offer. The opening of this training facility will provide greater access for the Australian electrical industry to receive high quality training of KNX. RMIT plans to incorporate KNX elements into multiple disciplines across trades, technicians and undergraduate programs.

The talent of our integrators and tradespeople has achieved worthy recognition to an international audience and as the KNX protocol continues to grow in Australia with the acceptance of KNX as the world's only standard for home and building automation, we are confident of further recognition of Australian talent on the world stage.

KNX Australian Board Members and contacts

Chairman

Ian Richardson
+ 61 418 53 15 99
chairman@knx.org.au

Secretary

Peter Garrett
+ 61 405 11 12 21
secretary@knx.org.au

Treasurer

Alistair Grice
+ 61 405 11 11 22
treasurer@knx.org.au

Training

Rene Rieck
+ 61 401 70 94 19
training@knx.org.au

Sales & Marketing

Ian Richardson
+ 61 418 53 15 99
chairman@knx.org.au





Australia's first KNX certified training centre opens at RMIT University



RMIT University has launched a new building automation training facility, enabling all electrical engineering undergraduate and apprenticeship students to gain expertise in the world-leading KNX automation system.

In collaboration with power and automation engineering company ABB Australia, RMIT has established itself as a leader in automation research and education. RMIT's new facility is the first KNX certified training facility in Australia, with sign-off from the KNX Association in Brussels. Learning how to use the KNX protocol will enable RMIT students to design and program

projects encompassing a large number of manufacturers using a world standard system.

Mr Peter Ryan, Head of School of Engineering (TAFE), believes that this partnership with ABB Australia will provide enormous benefits to RMIT.

"It is going to help expose our apprentices and industry partners to new skill sets" said Mr Ryan.

Professor Peter Coloe, Pro Vice-Chan-

cellor Science, Engineering and Health and Vice President of RMIT University, told the audience at the launch how important partnerships are for the University.

"This is a very important day for RMIT because it's bringing together industry, higher education and TAFE in an integrated way to deliver outcomes not only for RMIT but for Australia," said Professor Coloe.

KNX training equipment



Professor Peter Coloe (RMIT) accepts the KNX Training Centre Certification from Ian Richardson (Chairman KNX National Group Australia) as John Beniston (ABB Germany) looks on



RMIT staff and industry partners at the KNX training facility





Six green stars for KNX System

ANZ is one of the four leading banks in Australia and one of the two major tenants of the new ANZ Tower being constructed at 161 Castlereagh Street, Sydney. The other major tenant is the global law firm Herbert Smith Freehills. Designed by leading architects Francis-Jones Morehan Thorp and being developed by Grocon, 161 Castlereagh Street has been awarded the highest possible 6 Star Green Star – Office Design v2 rating by the Green Building Council of Australia.

Due for completion in March 2013, 161 Castlereagh Street has a net lettable area of 59,000 m² over 44 levels and features a number of sustainability features including high efficiency chillers, a tri-generation plant, a thermally shielded automated façade and rainwater harvesting. The design of the building's iconic roof structure and highly glazed façade allows high levels of daylight into the floor-plate.

One of the key sustainability initiatives in the building is the KNX lighting control system from KNX Award-winning Systems Integrators mySmartCTI. At over 1,800 devices this is the largest and one of the most prestigious KNX projects in Australia.

mySmartCTI were awarded the three major components of the project comprising the base building and the tenancy fit-outs of ANZ and Herbert Smith Freehills. The two main requirements of the lighting design were the need for flexibility in configuring the open-plan office spaces, including any future re-configuration, and the need to maximize the efficiency of the lighting solution to reduce energy consumption. The lighting control solution uses KNX control with the lighting ballasts on DALI networks. KNX/DALI Gateways from ABB ensures streamlined connectivity. An ABB KNX touchscreen located close to the lift core on each level and Hager KNX wall switches strategically located throughout the floor allow the users to manually operate the lighting in specific areas when required.

To ensure the building's lighting system uses the minimum amount of energy, daylight harvesting and presence/absence detection strategies have been

employed. KNX detectors throughout the building constantly monitor the ambient daylight levels across the floor and automatically adjust the lighting to suit. Combined with the presence detectors this ensures that the optimum light level is delivered whilst reducing energy wastage. Specific attention has been paid to after-hours lighting. Naturally the safety and security of any occupants working late is paramount and this is ensured whilst also using a minimum level of energy to do so. This is achieved through the highly flexible lighting control solution and numerous user interface points. Another highlight of the project has been the interfacing of the tenants' AV requirements into the KNX lighting control solution. To achieve this over, 30 AMX KNX interfaces have been used throughout the building's meeting spaces allowing the setting of lighting scenes and controlling the curtains and blinds within these rooms.

An ethernet backbone runs through the building linking the NETx Automation Voyager based lighting control server to the various KNX networks. Finally the KNX lighting control solution is interfaced to the building management system via a KNX/BACnet interface. This allows scheduling of the lighting in areas throughout the building including offices, carparks and the external lighting and signage from the BMS.

The team is mySmartCTI is looking forward to delivering another iconic KNX project. Says Peter Garrett, mySmartCTI's Managing Director, "This project is a win for KNX. To have a high profile tenants such as ANZ and Herbert Smith Freehills, and a leading 6 Star Green Star building committed to an integrated open-platform operating system such as KNX is huge boost for the profile of KNX in Australia."

Benefits provided by KNX in this project

- Increased energy efficiency through intelligent lighting functions
- Comfortable working environment due to optimum lighting levels
- Minimisation of after-hours lighting wastage control strategy
- Highly flexible for changes in tenants/uses



Companies involved

Building owners

GPT Group, LaSalle Investment Management und ISPT

Architect

Francis-Jones Morehan Thorp

Development and Construction

Grocon

Systemintegration

mySmartCTI, North Ryde, Australien

Area of Application

Commercial Offices

Functions

- Lighting
- Media Technology
- User Interfaces
- BMS Interfaces
- BMS Scheduling

Scope

Number of KNX devices: 1,800+ devices, ABB, Hager, HDL, NETx

Costs

AUD 1,100,000

Technical refinements

- Presence detection based lighting
- Daylight harvesting
- Constant level lighting for energy efficiency
- Highly configurable floor-plate – DALI Gateways, KNX touchscreens
- AMX Interfaces in Meeting Spaces
- BMS Interface (BACnet)





KNX Controls Western Australian Football & Rugby



Perth, Western Australia has seen a slew of major public building projects recently, one of which is the 95 million dollar upgrade to the city's premier rectangular pitch stadium. With building efficiency and central control an absolute necessity in every major construction project, the stadium improvements were not only cosmetic but also include complete electrical and control systems upgrades to better manage game-day scenarios.

Auto Control Systems has been contracted to install a KNX system to provide comprehensive, centralised control.

Some of the features include:

Pitch Lighting

KNX controlled lighting will provide four distinct lighting levels suitable for training programs through to the standard required for HDTV broadcasts (1400 lux). Control takes place in the main control room with local override when necessary.

Energy Monitoring

ABB i-bus® KNX based power monitoring devices provide real-time and historic stadium power usage figures. These take into account tariffs and power company specific billing specifications. Tenancy of individual store/refreshments operations are managed

with billing class power meters to enable exact receipting of electricity. There is also KNX monitoring of water meters to provide real-time and historic stadium usage figures.

Auxiliary Lighting Control

Normal building lighting needs are also managed with KNX such as control of all stadium lighting from toilets to corporate boxes to patron entry/exit points. Also managed via KNX are dimmable DALI ballasts and scene control for coloured stadium lighting in seated areas. The stadium will support the Western Australian teams by lighting up in their team colours. ABB i-bus® KNX real-time management of light levels according to environmental factors will also help to minimise power usage.

Emergency Lighting Management

Interconnection and management of all emergency lights and exit signs will be via DALI ballasts. Local and remote self-test options are managed by the ABB i-bus® KNX DALI Emergency Gateway. Error reporting and detailed fault analysis avoiding the need for a stand-alone emergency lighting system or duplicate wiring.

Companies involved

Building owners

Western Australian Department of Sports & Recreation

Architect

Cox Howlett & Bailey Woodland

System integration

Auto-Controls, Welshpool, WA

Area of Application

Sports Stadium

Integrated Control

The KNX control room will feature a 22" colour touch display. Monitoring of all lighting controls, emergency systems and utilities will be performed through this interface. Feedback of stadium usage figures will be presented through a custom designed graphical user interface putting the right information at the users fingertips. Management of light scenes and lighting levels can be managed from the central touchscreen or from a tablet device which will communicate via the wireless network system.

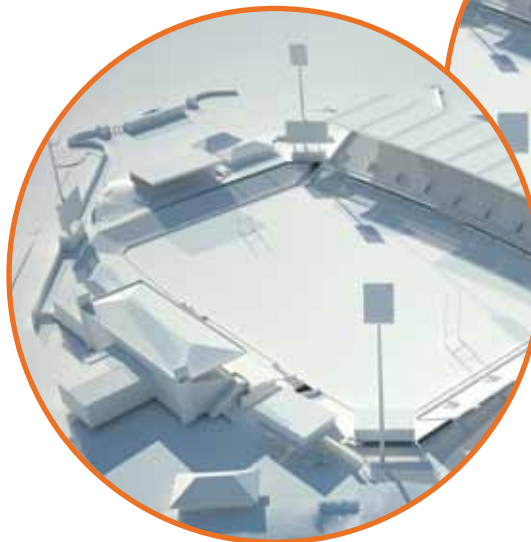



Monash University New Horizons



The New Horizons project is a joint development for Monash University, a leading Australian university and the Australian government research organization, CSIRO. The new building will be dedicated to research activities on material engineering including computational and physical modelling of manufactured products and services in the bio-medical, aerospace and renewable energy fields. Located in the suburbs of Melbourne, the development will establish the Monash University Clayton Innovation Precinct as the most significant technology innovation hub in the southern hemisphere. The New Horizons Project is a key component in the 10-year vision for a long term, comprehensive strategy for the Clayton Innovation Precinct.

The building is a reinforced concrete structure of approximately 20,000 m², split over four levels. The building is enclosed with an 'iconic' facade representing the high-tech nature of the research activities being conducted within. The building comprises of research space divided between open plan office and laboratories, including PC2 laboratories. Significant open areas for public circulation and meeting points have been design between the laboratory and office areas.

Ecoview have been awarded the Lighting Control, Automation and Energy Monitoring packages and have been undertaking the project in conjunction with the major electrical contractor, Stowe Australia. Ecoview's open architecture design is capable of expansion upgrades to suit any future requirements of the installation.

Ecoview's Lighting Control System solution is based on KNX, the worldwide standard for home and building automation. Switching and switching zones will be operated by relay modules and controlled locally by switch-plates. Motion sensors in the laboratories, toilets and other areas will control lighting when movement is detected, optimising efficiency and safety. Daylight harvesting was provided in specified are-

as via KNX/DALI gateways, compatible with dimmable luminaire control gear. An essential requirement from the customer was the uninterruptable power supply of all the facilities in this building. Ecoview's KNX control system and Energy Monitoring system will record the overall power consumed (kWH) and power consumed in nominated sections of the EMS System. The KNX Control System will also monitor the normal power supply at the main switchboard and each automatic transfer switch location as well as monitoring the signal to start the generator standby supply in the event of power failure. The KNX Control System will shed all load and automatically transfer the essential load from the normal supply to the standby supply in predetermined load steps as per "Priority Listing". When mains supply has been re-energised, it will transfer the load back to mains supply in an orderly fashion. The KNX Control System will provide a back-up transfer system in the event that either the main supply has failed, the Head End control system (within Building Managers Office)

Client
Monash University and CSIRO

Builder
Probuild

Architect
Lyons Architects

Systemintegration
Ecoview Integration Services

has failed and standby power is available at the transfer switches. Under these conditions, the local transfer switch logic shall take control and transfer to the standby supply in a sequential order. The control of the system and data shall be recorded in a dedicated IPC with a SCADA program which shall send selected information and alarms to the BMS System.

The design has been based upon the KNX open architecture model and the systems integration has been completed by Ecoview's in house engineers. The completed system provides the client with a well proven, easily adaptable standardized system, which has the ability for future changes already built in.





Using KNX to enhance industrial applications



It has long been thought that industrial based PC's and PLC's are the sole domain of complex industrial control and are stand-alone solutions to automation needs. However, using smart engineering and integrating KNX with these industrial technologies, it can deliver an integrated, cost efficient and user-friendly automation solution.

One of the most interesting examples of this application was for a client who required a bespoke system for their broadcasting vehicles. Systems Intelligence was briefed by the client – Grass Valley to develop and implement a lighting control system for a new range of sports broadcasting truck. After initial consultations, Systems Intelligence identified that energy monitoring capability would enhance the trucks environment and operating performance. Of note was the High Definition and electronic computer equipment within the vehicle that would need precise control and cooling to the appropriate temperature.

Grass Valley had previously considered and discounted this option, as they desired only one system to be implemented for ease of use, and were unaware that this could be delivered. After presenting how KNX – the best solution for the lighting control – could be integrated with industrial PCs into one system, the project scope was expanded. In addition to lighting control it included air conditioning, temperature control, load shedding and sequencing, alarming, phase control, surge protection, fire alarms and metering. To assist the end client in managing the system, visualisation was also included. This involved a 15" user-interactive touch screen with intuitive menu so that the whole system could be seen easily and efficiently by the Senior Engineer and Director when the vehicle was in broadcast mode. It also allowed the user to control the installation from a central location. The easy and seamless integration of KNX network into a PC based system ensured the development time was short and opened up an array of opportunities for adding extended

control to the overall system. Systems Intelligence was also able to provide a system redundancy due to the KNX system being a distributed control system on which devices function independently of a central controller, combined with a Windows Embedded IPC. In summary, KNX's ability to integrate with so many applications gave our client far more choices, capability and ultimately a better control of the vehicle. The ability to manage all components on the one system for control, energy management, safety and user comfort and versatility was critical. KNX offered all this and more. System Intelligence dispelled the myth and leads the way in developing integrated solutions across a range of industries that are user-friendly and cost efficient.

Benefits of KNX

- Ease of integration with other systems which was required due to the complexity of control required
- User-friendly nature
- Ease of information to enable visualisation
- Reduced cost of developing a holistic control solution
- Ease and speed of programming with ETS4 which also assisted when client needed to make changes late in the project i.e. were able to keep project deadline and deliver on time

Facts and Figures

Client

Sky Racing Australia
(Frenchs Forest, NSW Australia)

Project Manager

Grass Valley (Notting Hill, VIC Australia)

Systems Integrator

Systems Intelligence (Doncaster East, VIC Australia)

Area of Application

Outside Broadcast Vehicle Horse Racing

Functions

- Lighting
- Heating and Cooling
- Energy Management
- Load Shedding
- Visualisation
- Interfacing to other systems
- Fire alarming
- Electrical supply phase rotation monitoring
- Energy Metering
- Technical monitoring

Scope

Number of KNX devices 26
(ABB and Beckhoff Automation)

KNX Costs

\$ 45,000 AUD

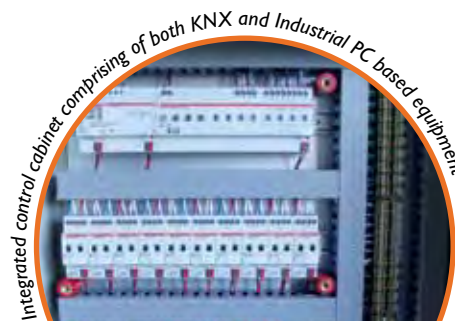

Broadcast vehicle





Cameron Australasia



Lynx Integrated Systems were successful in winning the Building Automation Solution for Cameron Australasia's new centre of operations at Kewdale in Perth. Cameron Australasia, a supplier of equipment to the international oil and gas sector, began work on their \$120 million workshop facility.

Lynx's scope of works was to design and commission a complete building automation system solution to the 3,000 m² office and an 8,445 m² workshop and warehouse.

Solutions included user control 'GUI interface', control of all lighting, monitoring of the exit & emergency lighting and integration with the Building Management System & security system.

Applications included were a combination of local control, timed control, PE cell control, present detection, remote and automated control, day light har-

Benefits of KNX

- Increased energy savings
- Distributed intelligence for flexible & reliable control
- Control of individual lights
- Status reporting on lamps and ballasts
- Simple modifications – no need to alter 240 V wiring
- Lower maintenance costs

vesting and a fully monitored exit and emergency lighting system to the entire project.

Special features included the use of DALI light fittings & emergency light fittings on the one system.

The result – state of the art energy efficient building automation system giving the client complete control.



ETS4 product catalog, just by selecting the product and clicking the button "Import from online catalog...". Of course the option for the user to select the desired product languages to be imported remains untouched. Last, but not least, the user does not have to store the KNX product databases on hard disc any more, since all are always online and can be found in the Online Catalog.

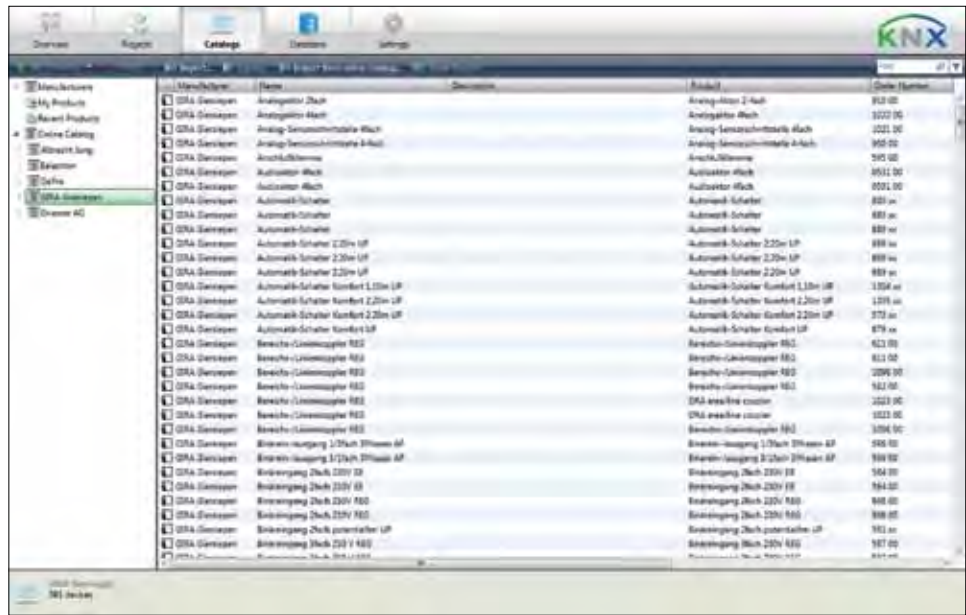

New ETS Apps

All ETS Apps you can find at www.knx.org → KNX Tools → ETS Apps → Features

Nautibus electronic GmbH

ETS App ELplan – Floor plan inside the ETS

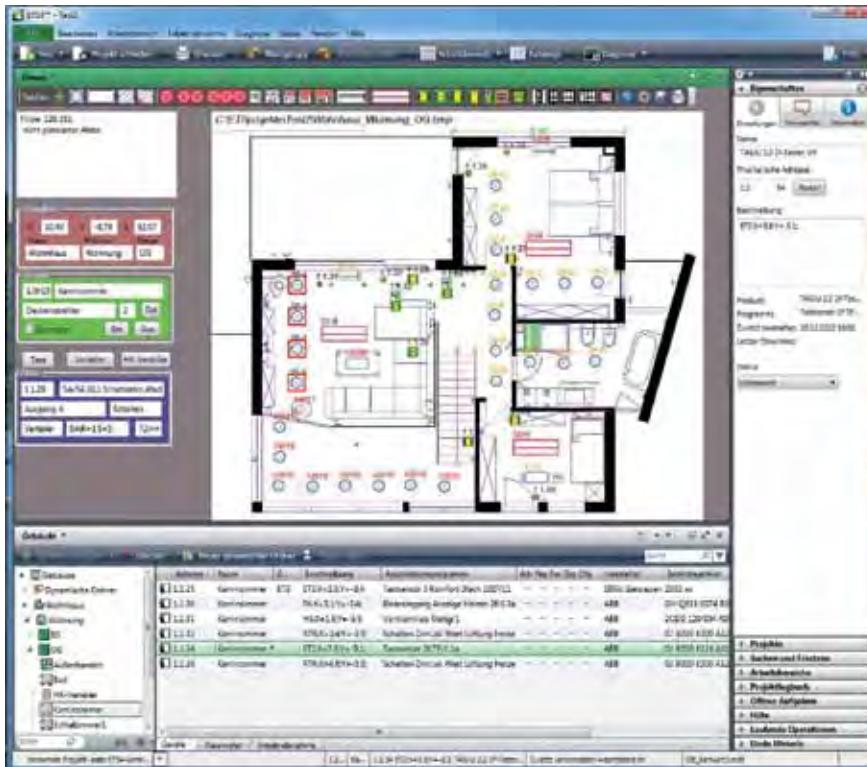

The ETS App ELplan extends the ETS with a floor plan view. After pre-selection of the desired KNX devices lamps, sockets, blinds, switch sensors, heating circuits, programmable thermostats, window contacts and radiator actuators can simply be placed in the floor plan. The ETS App ELplan app automatically generates the necessary group addresses with meaningful names, such as „lfloor_dining room_ ceiling lamp“. These group addresses are also automatically assigned to appropriate actuators. Even the rockers of the buttons can be programmed in the graphical user interface with a mouse click. A complete, well-structured and documented ETS project during the graphical input occurs simultaneously with the installation plan, distribution plan and bill of materials.

This ETS App saves from the experts a lot of work, gives the beginners a lot of help and provides in every case more clarity in the project.

Contact: www.nautibus.de

New Members



ITALY

AEM S.p.A.



AEM designs, develops and delivers systems and solutions that integrate all aspects of security and access control in a single architecture. Building protection is addressed via an integrated approach, one that allows building a complete facility management solution. Solutions for several application fields are offered:

- video surveillance
- access control (staff and visitors)
- monitoring & control

AEM designs and manufactures hardware products that are used together with on-line services developed by Acotel S.p.A., the holding company.

Contact: www.aem.net

SWITZERLAND

Air-On AG



The air, an integral part of life, affects quality of life and health decisively. Up to 90 percent of the air we breathe is inside rooms. High indoor air quality is therefore crucial to our well-being. Air-On AG has already managed to solve problems that often compromised the indoor climate and air quality. Air-On is revolutionizing air conditioning through the combination of five functions in one product: heating, ventilation, air purification, dehumidifica-

tion, and humidification. Intelligent control of the crucial parameters of indoor climate (temperature, humidity and CO₂) also saves massive energy. A KNX interface card allows Air-On to be integrated into building automation to support efficient control of the indoor climate and also save energy.

Contact: www.air-on.ch

BELGIUM

Duotecno BVBA



Duotecno offers an extremely user-friendly home automation system, enhancing comfort within the home in multiple ways. You can control virtually any feature in your home with its home automation solution: lighting, heating, electrical appliances, roller shutters, audio, video, alarm and video intercom. You ensure your own safety and prevent wasting energy. Above all, the system is very flexible: you can set

your entire home to your liking by a single key touch. Duotecno BVBA intends to develop products on the KNX platform to further extend possibilities in own projects. At a later stage they are planning to manufacture interfaces, push buttons and detectors compatible with the KNX system.

Contact: www.duotecno.be

JAPAN

Fujitsu General Limited



Fujitsu General Limited, established in 1936, is a worldwide manufacturer of air-conditioners, electronic devices and a provider of IT related system products and services. The headquarters are located in Kawasaki, Japan. Their main product gamma are air conditioners; with product lines ranging from room air conditioners, multi type system to VRF system for buildings as well as air to water appliances. In the fiscal year of 2011 fiscal Fujitsu sold

products to customers worldwide for about 200,000 million yen. It has over 30 subsidiaries around the world, including factories. Fujitsu General is a member company of the Fujitsu group, headed by Fujitsu Limited, a Japanese IT giant, who does not own the company, but is a major shareholder of Fujitsu General.

Contact: www.fujitsu-general.com

CHINA

Hefei MR Electronic Technology Co.,Ltd



Hefei MR Electronic Technology Co. is committed to research, development, design and manufacturing of intelligent lighting control and room control systems. System products are widely applied in public buildings, stadiums, exhibition centers, shopping malls, villas, luxury, upscale hotels, office buildings, supermarkets and

other places. Projects such as the Anhui Paleontological Museum, Hefei Choi Chi square, Tianjin Hedong Wanda Plaza, Hefei City Shushan District People's Procuratorate, the Huainan municipal office building, are praised by its current users.

Contact: www.mrtlc.com.cn

GERMANY

Helios Ventilatoren GmbH + Co KG



DIE MARKE DER PROFIS

Helios stands for ventilation technology of the highest quality for every application: from compact small fans on ventilation systems with and without heat recovery to complex solutions for industrial and commercial applications. Large fans with flow rates up to 2.2 million m³ / h and solutions for building services complete the range. Part of the product philosophy are intuitive user interfaces for an easy use. This includes the integration of Helios ventilation systems in building control sys-

tems using KNX application modules to further maximize comfort. Helios is one of the leading manufacturers of ventilation equipment. Next to the headquarters in Villingen-Schwenningen, the company operates nationwide with approximately 25 sales offices in Germany and with offices and subsidiaries in over 20 countries in Europe.

Contact: www.heliosventilatoren.de

GERMANY

ib company GmbH



ib company is a service provider for future oriented solutions in the residential and commercial sectors. Close contact with manufacturers and developers are always guaranteed to integrate the best product for your application. Comfort, efficiency and flexibility are most important for the company. Customers benefit from the expertise of the ib company and their ser-

vices. They work manufacturer independent, product neutral and master multiple disciplines. Their activities are: lighting control systems, video and audio systems and media technology, HVAC systems, visualisation of building management and energy data.

Contact: www.ib-company.de

AUSTRIA

Illumination Network Systems GmbH



Illumination Network Systems GmbH (founded 2009) develops and manufactures infrared sensors and controllers for outdoor lighting and home/building automation. The active sensors provide detailed information about movement direction, speed, position and status of the occupant. With this information, optimal lighting for occupants is provided timely and inconspicuously. The sensor information can also be used for further build-

ing control functions i.e. heating, power supply, shades, surveillance and ambient assisted living. The sensors are intended to replace current movement or occupancy detectors. An embedded IP interface allows actively communicating with in-house computer networks and act as a gateway to the KNX system.

Contact: www.illuminesys.com

ITALY

Kalpa srl



Kalpa is an Italian consultancy company focused on the design and development of embedded software, firmware and high-tech systems. The goal of Kalpa is to contribute, through high-tech choices and specialised support, to the creation of innovation and value for companies operating in the embedded world. Thanks to its cross-competency teams, Kalpa is able to

develop innovative solutions tailored to different areas, from home automation to process automation, from telecommunications networks to biomedical devices, energy and equipment, from electrical to electronic devices.

Contact: www.kalpa.it

TURKEY

Makel Elektrik Malz. San. Tic. A.S.



Makel began its activities in the electrical sector in 1977 and started to manufacture electric switches and sockets in 1987. Today the company has extended the range of its products with group sockets, circuit breakers, fuse boxes, electricity meters, reactive power control relays, panel meters and GPRS modems for Advanced Metering Infrastructure applications. Makel offers its products to consumers in domestic and foreign markets under the Makel trademark guaranteeing high qual-

ity. Makel exports its products to more than 30 countries through foreign partners. With its powerful R&D background, staff and test lab facilities, Makel intends to enter the home automation market, a natural extension to Makel's product portfolio. Makel's production facilities in Istanbul with a surface of 45,000 m² use the most advanced automation machinery and technologies.

Contact: www.makel.com.tr

GERMANY

Nautibus electronic GmbH



Nautibus elektronik GmbH specializes in the development of fieldbus modules for industrial use. The main product line includes master and slave interfaces for Profibus-DP and CAN bus modules. In the area of yacht electronics, there are modules for CANbus in compliance with the NMEA-2000 standard. In the future they

will focus on software products for configuration and visualisation of bus systems. In addition to the Profibus configuration tool sector and NMEA-2000 products, they will now also bring KNX-products to the market.

Contact: www.nautibus.de

CHINA

Ningbo Dooya
Mechanic and Electronic
Technology Co., Ltd

Ningbo Dooya Mechanic and Electronic Technology Co., Ltd is a global leading manufacturer of smart home systems and window & door automation. It mainly produces smart home products, tubular motors, motorized curtains, venetian blinds drives, window openers, control systems and related accessories. Products are CE, VDE, TUV, UL, FCC, ROHS, CCC, etc. certified, to meet the strict requirements of different countries. Ningbo Dooya developed a series of KNX products for use

in the smart homes and buildings, such as a switch actuator, a shutter/blinds actuator, sensors and a KNX gateway. Many KNX devices will be developed in the future in order to support a full-function system. Ningbo Dooya also has gateway products to connect KNX to other networks, e.g. a KNX-Zigbee gateway and a KNX-433 MHz gateway.

Contact: www.dooya.com

BELGIUM

Nomics SA



Nomics is a developer of innovative electronics products and a design house in the field of signal measurement, processing and transmission. With its ISO9001 & ISO13485 certified quality system, the company is present on medical as well as industrial markets. Its wireless branch developed magnetic technologies for data

transmission through metals and various very low power autonomous sensor networks. Nomics is currently designing an autonomous system of sensors to be embedded in windowpanes for KNX home automation applications.

Contact: www.nomics.be

SINGAPORE

OTTO SOLUTIONS
PTE LTD

Established in 1992, Otto Solutions Pte Ltd has played a leading role in providing complete eco building solutions in the four critical areas of Design, Automation, Lighting, and Electrical systems, bringing commercial, industrial and residential buildings to life. Having established a strong track record in Singapore, Otto is the preferred choice for such building solutions. Otto strives to continue its presence in Thailand, Malaysia, Myanmar and China. In addition to its in-house designing team,

Otto also works with top product designers around the world to continuously develop innovative D.A.L.E. products for the market. The company also partners with building consultants and contractors. Otto is a growth-oriented company that is constantly looking for new markets to expand into, and welcomes like-minded manufacturing companies to join its international expansion.

Contact: www.ottosolutions.sg

AUSTRIA

Pipelife International GmbH



The Pipelife Group has a very strong commitment to the electrical market and provides a full range of plastic pipes, fittings and accessories that form a very attractive and competitive package for electricians throughout Europe. The product range consists of metal and plastic conduits for electrical installations as well as a full range of accessories for the installation and use of these conduits, such as bends, couplers, and a line of fixing materials.

Individual solutions are also provided to meet special requirements. The growing range of Pipelife electrical systems serves the needs of electricians in the domestic, commercial and industrial sector and meets national and international standards and regulations. Pipeline offers a full range of electrical products in most of its local branches and on export markets.

Contact: www.pipelife.com

CHINA

Shanghai Longchuang Automation Control System Co., Ltd.



Shanghai Longchuang Automation Control System Co., Ltd. is a high tech company founded in 1999. It's known as one of the best system integrators in the intelligent building field in China. It focuses on intelligent building and lighting control products, solutions, service and system integration, with many well-known successful projects in building energy efficiency, lighting control, luxury hotels and

smart homes. Longchuang installed KNX successfully in many projects, including venues of the 2010 Shanghai World Expo, Hongqiao Airport Terminal 2 and Expo Intercontinental Hotel. Longchuang hopes to make greater achievements in the field of KNX and develop more products and applications to increase energy efficiency.

Contact: www.longchuang.com

GERMANY

STG Beikirch GmbH & Co. KG



STG-BEIKIRCH GmbH & Co. KG has been developing, designing and manufacturing automation system solutions and intelligent facades for smoke and heat extraction systems and controlled natural ventilation for over 30 years. STG-BEIKIRCH is a system partner of the Europe-wide operating ESSMANN GROUP. Since domestic and international climate-related natural ventilation via an electric motor operated windows is an extremely energy-and cost-efficient alter-

native to mechanical ventilation systems, STG-BEIKIRCH has developed an intelligent system solution together with the company GIRA, so all functions could be monitored, controlled and programmed via the KNX bus. Through a sophisticated combination of sensor and actuator components, the climate is always adapted to the current requirements and the individual needs in every single room.

Contact: www.stg-beikirch.de

GERMANY

STMicroelectronics Application GmbH



ST is a global leader in the semiconductor market serving customers in the field of sensor and power technologies and multimedia convergence applications. From energy management and savings to security, from healthcare and wellness to smart consumer devices, in the home, car and office, at work and leisure, ST micro-

electronics is found everywhere making a positive and innovative contribution to peoples' lives. With its technology people get more out of life; ST stands for augmented life. In 2011, the company's net revenue amounted to \$9.73 billion.

Contact: www.st.com

CHINA

Guangzhou Tantron Electronic Co., Limited



Guangzhou Tantron Electronic Co., Limited is a high-tech enterprise, specializing in intelligent home and building control systems, product development, production and marketing. The company has a R&D team with many years of experience in KNX. In 2010 it successfully launched the Tantron-bus for KNX intelligent home and building control system products. Tantron is innovative, competitive, market-oriented, committed to providing customers with professional, personalized

products. Tantron's products are sold to domestic and foreign high-class hotels, large public venues, commercial buildings, villas, homes, etc., and meet the customer's unanimous approval and praise. Tantron's team will continue to support with rapid response, positive, flexible market adaptability, to meet customer needs in different regions, providing customers with quality products and services.

Contact: www.tantron.com.cn

NORWAY

Vitheia AS



Vitheia is a software and hardware design company specialised in online collaboration & conferencing solutions and industrial distributed control systems used in wired and wireless environments. Since its foundation, the company has been providing complete intelligent building automation solutions: both hardware and

software products in order to meet various customer requirements quickly and efficiently. The company wants to extend the list of supported technologies by integrating KNX into its monitoring and controlling software.

Contact: www.vitheia.com

TURKEY

Yonnet



Yonnet is an R&D company founded in 2008. It focuses on smart building components and manufactures touch panels to control KNX systems and systems for intercom, alarm, camera monitoring and smart metering. Yonnet has a network of 15 dealers in Turkey. It has just started

production of KNX products based on the Tapko stack. Yonnet plans to produce actuators, push button interfaces and power supplies.

Contact: www.yonnet.com.tr

New KNX Products

ABB Stotz-Kontakt GmbH

ABB i-bus KNX DALI Light Controller DLR/A 4.8.1.1



With the new DALI Light Controller DLR/A 4.8.1.1 ABB expands its offer in the field of DALI lighting control and decentralized installation. Up to 64 DALI members can be assigned to eight groups of luminaires. In combination with light sensors the device features four fold constant lighting control. Lighting scenarios can support the room utilization demands with up to 14 scenes. A staircase lighting function facilitates time-dependent lighting control. Because of the surface mount body, the device can be used in subceilings or underfloor-installations.

Contact: www.abb.com/knx

ABB Stotz-Kontakt GmbH

ABB i-bus® KNX Room Master RM/S 3.1 and RM/S 4.1



Room Master RM/S 3.1 and RM/S 4.1 are ABB's latest additions to their range of Room Master solutions for apartments, hotel rooms, offices, etc. The RM/S 3.1 accommodates four switch outputs, four blind / switch outputs and 12 binary inputs. The RM/S 4.1 accommodates eight switch outputs and eight binary inputs. As a special feature of the Room Master product family, the new devices also have an internal connection function for all input and output channels without group addresses. Internal connections can be programmed with the ETS software. The Room Master integration into a KNX system is also possible. Inputs and outputs can also be linked through ETS with group addresses like any other KNX device.

Contact: www.abb.com/knx

ABUS Security-Center GmbH & Co. KG

Ultivest Wireless Alarm System



The new high-end wireless alarm system Ultivest combines active burglary protection with mechanical and electronic components, access control, video integration and connection to the building management system via a KNX interface. The priority was to create a system for people who don't want make compromises when it comes to quality, function, design and comfort. In order to do provide the enormous range of functions the wireless alarm system provides, the company is blazing new trails in distribution: The Ultivest Wireless Alarm System will be available via an exclusive network of specially trained Ultivest installers.

Contact: www.abus-sc.com

b.a.b.-technologie GmbH

BAB CubeVision



With the visualisation extension "CubeVision" for the eibPort, BAB Technologie succeeded in combining innovative visualisation design with low configuration effort. The CubeVision offers a new type of animated User Interface Design and intuitive usability. It automatically adapts the user's habits and provides room for individual wishes at the same time. Thus the CubeVision unites two sales arguments which were contrary until now: It offers innovative and individual design at low installation costs.

Contact: www.bab-tec.de

b.a.b.-technologie GmbH

BAB DataLogger



The new "BAB Datalogger" of the company BAB Technologie offers the ideal solution to record telegram data. The device is mounted tamper-proof on the DIN Rail and contains an internal, up to 16 GB expandable storage. The data is either collected directly via the KNX bus or over the network protocol KNXnet/IP (KNX/IP Router). A filtering function for the integrated MySQL database record exports the device data as an excel file. The configuration of the device is comfortably done via browser or directly via the integrated two-line display and the related push buttons; a PC is not required!

Contact: www.bab-tec.de

basalte

Asano Audio System



Asano is a networked multi-room audio system that allows you to freely locate your sources and amplifiers. Using CobraNet, Asano transports uncompressed crystal clear audio from any source to any room over a dedicated Ethernet network, offering unseen flexibility and expandability. Asano is powered with Bang & Olufsen ICEpower Class D amplification. With the internal advanced DSP, you can fine-tune your sound in every room, creating the ultimate listening experience. Asano integrates perfectly with KNX systems, without any interface. It neatly integrates with ETS, which allows a uniform and easy setup and configuration of the system.

Contact: www.basalte.be

basalte

New Software for Sentido



Sentido, Basalte's highly innovative touch sensitive KNX switch, now comes with a new application. One of the main new features is the room toggle. With this feature, it is possible to switch the lights in a room on or off with a single touch. Sentido now also includes a fully functional thermostat and a scene controller. The switch itself can now execute scenes, whereas before they had to be programmed in the actuators. Also new is the RGB controller, to respond to the rising demand to control RGB fixtures. The new software improves this already fantastic light switch, and brings it to a new and unequalled level of functionality and ease of use.

Contact: www.basalte.be

Berker

KNX universal dim actuators REG



Apart from familiar light sources such as incandescent lights and high-voltage and low-voltage lamps, the dimmers also control modern types such as LEDs and energy saving lamps, and automatically adapt to different lighting loads due to an innovative dimming technology. Berker offers two 1-channel units and one 3-channel module that can be flexibly adjusted from 3x300 W to 1x300 W plus 1x600 W and 1x900 W. Apart from standards-compliant dimming of LEDs and energy saving lamps, the products also feature extremely low standby power consumption. The dim actuators can easily be controlled with all types of sensors and are also ideally suited for integration into visualisation units such as the Berker IOS.

Contact: www.berker.com

Bischoff Elektronik GmbH

Universally useable Linux platform



Equipped with a "Sitara"-ARM Cortex A8 processor from Texas Instruments with 128 MB-SDRAM and 512 MB flash this hardware solution provides a range of interfaces like: wireless M-Bus module, SD-card interface, 3-times USB2.0 host, galvanically isolated digital inputs and outputs and RS485-Bus as well as Ethernet and RS232 port. The system also has an integrated KNX interface with which you have access to up to 250 KNX objects. An ETS4 application is in development. Because of the use of the Linux operating system it is possible to realize own software solutions and projects.

Contact: www.bischoff-elektronik.de

**B.E.G. Brück Electronic GmbH
PD11-KNX FLAT-FC**



With an only 0.8 mm high visible border, B.E.G. offers the latest addition to its B.E.G. KNX range. The PD11-KNX FLAT is added to the series of KNX enabled occupancy detectors and extends it to a discrete solution for monitoring areas up to Ø 8 m. The neutral and modest design of the PD11-KNX FLAT-FC is the choice for home users: Thanks to its specific housing, the device can be installed to save space in a secure way. By using structured application software, the new PD11-KNX FLAT-FC can easily be integrated into existing systems; compatibility and usability are guaranteed from the beginning.

Contact: www.beg-luxomat.com

**Bilton International
KNX with Master-Slave function**



LED-Controllers can be so simple: The master-slave-function in BILTON International devices facilitates installation and programming. Whoever installs LED-lighting, will appreciate this facility. For example, the facility of operating 30 KNX devices with a single signal control: the "Master". Simply put, all other "Slave" devices will follow its exact instructions. This offers a great ease of use for customers. In addition, all of these KNX controllers have a built-in 100 W power supply.

Contact: www.bilton.at

**Bischoff Elektronik GmbH
The new compact 12-fold switching actuator SA12**



The new 12-fold switching actuator with 6 x 16 A and 6 x 8 A (AC1) outputs enables a space-saving assembly in the electrical distribution panel with just 6 TE. Therefore it is especially suitable for distribution boards in apartments and single-family houses. The software equipment includes common functions like staircase lighting timer with forewarning, logical connections, scenes, preset, threshold evaluation and safety. Furthermore the device has a counter for load operating hours, separately for every output, and additional five logic blocks and five timing elements. The logic blocks each have four input objects that are connected logically with each other.

Contact: www.bischoff-elektronik.de

Bitwise Controls

Bidirectional IP based “BC2” Audio/Video controller with KNX integration



The new IP based home automation controller BC2 allows complete KNX integration and the creation of personalized user interfaces using ready designed, customizable templates. Purchase a GUI set only once, and use it on all future projects (updates to the GUI included!). Control all Audio/Video equipment together with the KNX installation in one customizable App. No licenses are necessary, install and configure the App on as many devices you like (iOS and Android). New functions: Control shutters and exterior lights using the installed astronomical clock or annual real time scheduler and send an email alert on a KNX event.

Contact: www.bitwisecontrols.com

CE2 GmbH

MULTICON Media System



The MULTICON Media System is the ideal multimedia complement for KNX installations for demanding customers. The system works on a client/server basis and stores any music, TV-recordings, movies (DVD / Blu-ray) and photos centrally and safely on a NAS. It streams live TV and movies in HD quality over the network and allows the ripping of any disc. It is a multi-room system for TV, film and music. Besides the control of the media system the customizable user interface for tablets or smartphones allows a fully integrated control of KNX installations and multimedia (TV, projector, matrix, etc.). – via IP-Gateways/Controller.

Contact: www.multicon.at

Dialogic Systems

“HomeCockpit Major” – now with external speaker connector



Top performance at the touch of a button – its powerful Dual Core Intel Processor enables the modified multi-touch panel PC to execute commands even faster. The innovative hc-communicator software enables it to be controlled remotely using UDP telegrams. It's possible to make your own videophone interfaces in a visualisation system or bring any Windows programs into the foreground on the screen using simple commands. It also has a connector for external speakers to make the panel the ultimate multimedia platform. Want even more? It also features optional KNX and IWire ports.

Contact: www.home-cockpit.de/major

BleuComme´Azur

“KNX-proServ” – now with new Apps and new ETS product database



Programming visualisation takes more time than programming the KNX functionality? Wrong! Using KNX-proServ this process goes faster as the graphical user interface is generated directly out of the ETS configuration. No license, no editor, no export/import of group addresses, no additional project necessary. proServ is configured with a new ETS product database, that now supports all possible KNX data formats. This only one configuration is the root for the native Apps on all types of Smart Phones and Tablets (iOS and new also for Android). proServ works with up to ten devices and may be even used as programming interface.

Contact: www.knxware.com.

Dialogic Systems

“HomeCockpit Excelsior” – now with Windows 8 operating system!



A new highlight for technology fans – its high performance Intel Core i7 processor allows the innovative multi-touch panel PC to execute commands in seconds. Its intelligent hc-communicator software enables it to be controlled remotely using UDP telegrams. With simple commands you can now bring any Windows program into the foreground on the screen or disable and enable spoken entries on the panel. The Windows 8 operating system with APP-based metro interface and the facility to switch to the classic desktop view imposes no limits.

Contact: www.home-cockpit.de/excelsior

Dinuy S.A.

CO KNX 002: KNX TP/RF Media Coupler



Dinuy introduces a new small bidirectional media coupler between KNX RF and KNX TPI. The CO KNX 002 allows using KNX RF devices in a KNX TPI installation. In this way it is possible to use, for example, wireless temperature sensors, light sensors or door / window contacts and have them communicate with TPI. It has 16 independent channels that can be assigned to lighting, blinds / shutters or HVAC system control. It has a very small size: 78 x 28 x 23 mm. Configuration is done via ETS3 or ETS4.

Contact: www.dinuy.com

Dinuy S.A.

**DM KNT 001:
Motion Detector with
Constant Light Control**



DINUY S.A. introduces a new multi-function motion detector with integrated bus coupler. Besides the main function as movement detector, the DM KNT 001 incorporates five configurable functions:

- constant light control
- twilight switch
- brightness sensor
- signal monitoring
- temperature sensor

This flush-ceiling mounting device has a detection range of 360° and 7 m diameter at a height of 2,5 m. The delay time and the brightness can be adjusted through its own control knobs, via ETS or with a remote control.

Contact: www.dinuy.com

easyMobiz mobile IT solutions GmbH

**Mobile KNX IP Stack
for Android + iOS**



The easyKNXLib makes efficient development of mobile KNX apps possible. KNX producers can rely on a professional KNX IP stack for their own iOS and Android apps. This high-level API includes functions for reading and writing group addresses as well as accessing memory and properties, supporting both KNXnet/IP tunneling and routing. easyMOBIZ has been developing mobile apps and working with KNX for the last five years. This experience is now available for other developers of KNX software, significantly reducing their time-to-market.

Contact: www.easyMOBIZ.com

Eelectron spa

**MB80AxxKNX
– MiniPad KNX 8CH.
+ Temperature Sensor**



With its eelecta® range, fully based on KNX, eelectron focuses on the residential market. The range is composed of KNX HomePads, MiniPads, Touch panel, Socket frame and won a number of famous design awards such as Red Dot, Design Plus & Interior Innovation. MiniPads are available in three colors with a new dimension of 90 x 90 mm. Eelecta's MiniPads feature a central cross, which customise the product with different finishes. The front has five LED status indicators freely configurable by ETS, one for each button channel plus the corner led useful for night localization. The MiniPads are available in models with four or eight channels, with or without temperature sensor to realize a room thermostat and with or without four rear free inputs.

Contact: www.eelectron.com

**Domotica – Global Solutions, S.A.
KNX Server Cloud Service**



KNX Server owners can now optimize energy use in all home and building installations, by fully integrating the KNX Server Cloud Service. This gives any KNX installation a full functional and cost effective Building Energy Management System that enables precise and real-time monitoring of energy, water or gas devices. Activity reports for each device can be created individually or by combination of various circuits and criteria, real-time control of devices (RGB, percent, On / Off, set point), and establish rules for automation and daily routines, accessible from anywhere, anytime.

Contact: www.knxserver.com

Eelectron spa

**IO32D01KNX –
Inwall 3 Input / 2 Output
Module**



The IO32D01KNX module for in-wall box installation is equipped with 2 x 6 A relays; two digital inputs and one analog input. Each output can be configured independently for load control or continuous switching. Outputs can be configured in pairs for the management of shutters. Digital inputs can interface free potential contacts as sensors, traditional buttons, etc... to send switching, dimming, blind/shutter control, sequences or scenes. The analog input can be connected to a temperature sensor in order to realize a room temperature controller for heating and cooling equipment, valves, two and four pipes fan coils, etc... Control algorithms can be different for heating and cooling.

Contact: www.eelectron.com

Elsner Elektronik GmbH

**KNX I4-ERD: Monitoring
the fill level of tanks**



The ultrasonic sensor KNX SO250 basic measures distances from 12 to 250 cm. The measuring head is resistant to fuel oil and water and can, for instance, be used for water reservoirs, ponds or oil tanks. The evaluation unit does not only output distances, but also calculates the fill quantity of liquids. Up to 100 similar, coupled tanks can be monitored. There are five threshold values for filling, emptying, protection against dry running and overflow indication. KNX SO250 basic is operated with bus voltage. The sensor cable can be extended to 40 m. The fill level sensor is also available as version KNX SO250 which features a display, push buttons and two additional output relays.

Contact: www.elsner-elektronik.de

Elsner Elektronik GmbH
KNX I4-ERD: Measuring
Ground Humidity and
Temperature



The evaluation unit for ground data KNX I4-ERD monitors the humidity concentration (Vol%) and the temperature of the ground. Up to four sensors can be positioned independently from soil conditions, thanks to the capacitive humidity measurement. The probes are non-wearing and maintenance-free. Connection cables can be extended to up to 100 m. In this way the soil irrigation for a large garden can be controlled automatically. The evaluation unit is mounted on DIN rail. Two threshold values for temperature and humidity can be set for each sensor in ETS. The accurate function is observed by a malfunction object.

Contact: www.elsner-elektronik.de

Exor International S.p.A.
DomiOP eBIS513



The DomiOP eBIS513 is an advanced KNX HMI device that combines state-of-the-art features and top performance with an outstanding design. It is the ideal choice for all demanding HMI applications in building automation and meets the need of remote monitoring and scene programming. The eBIS513 features a bright 13"3 widescreen TFT display with 1280 x 800 pixel resolution, fully dimmable LED backlight and support for 64 K colors. The two built-in dual 100 MB Ethernet interfaces with switch function enhance its communication capability. JMobile, Exor International's software platform for real-time monitoring and remote access completes the eBIS513 and makes it an innovative and efficient solution.

Contact: www.exortint.net

function Technology AS
KNX MultiController DALI



KNX MultiController DALI is a room controller with multiple functions in a single device for energy efficient building control in offices, commercial buildings and hotels. The compact design makes it ideal for ceiling and floor mounting. The WAGO Winstaplug provides a quick and easy mounting of the device. It replaces wall and ceiling mounted sensors, regulators and actuators, and includes the following functions: integrated KNX / DALI gateway with groups and emergency function, temperature controller, constant lighting controller, logic, two thermo relays, two relays (16 A), two binary inputs and one intelligent local sensor interface for reed user panel and/or movement sensor.

Contact: www.function-technology.com

function Technology AS
Reed



Reed is a sleek user panel with integrated temperature sensor. It has a unique and flexible design for installation on tables, in system walls and for standard wall boxes. Reed can also be integrated into suspended luminaires for optimal temperature sensing in rooms. Four buttons on the front allow the user to control temperature, blinds or light locally. Feedback LED's indicate the local temperature adjustment and heating or cooling mode. Reed is a part of the KNX MultiController and KNX MultiLight concept. The picture shown is the MultiController Reed (23090) with Reed Table base (23901).

Contact: www.function-technology.com

GePro
KNX panel
with new labeling system



From March 2013, the KNX panel with a new labeling system, an alternative to the existing engraving of the labels in aluminum, can be ordered. The label plates are made of transparent Plexiglas. The label is created individually by the customer, providing the possibility of colored icons, photos, etc. The completed sign is placed behind the Plexiglas label plate and bolted. A fast exchange is guaranteed every time. The surface mounting of KNX panel eight series will be available in the future for both horizontal and for vertical mounting.

Contact: www.knx-taster.de

Gira
KNX dimming actuators



Gira dimming actuators 1-fold, 2-fold and 4-fold enable the switching and dimming of light bulbs as well as HV and LV halogen lamps via inductive transformers and Tronic transformers. From device version Index 102 (V02) and software version 1.2, dimmable HV LED and compact fluorescent lamps can now also be switched and dimmed. The characteristic of the connected load can be automatically calibrated for each of the up to four output channels, and a suitable dimming behaviour can be set. Alternatively, dimming behaviour and parameters can be specified for each channel using ETS parameterisation, which facilitates ideal dimming.

Contact: www.gira.de

Guangzhou Hedong Electronic Co., Ltd (HDL)

Infrared Air-Condition control (HDL-M/IRAC.1)



The HDL-M/IRAC.1 supports four channel infrared interfaces and stores up to 650 infrared codes. 250 IR codes can be used for universal control, 400 can be used to control AC devices of any brand. The following functions can be realized: switching, temperature control, cooling / heating, fan speed control, swing control etc. Via software configuration, the user can choose following modes: single control, repeated control, AC control, sequence control and current detection. "Single control" can be used to control any IR interface device, "Repeat control" to repeat infrared controls instructions, "AC control" to control air-conditioning, "Sequence control" to control devices in a specified sequence, "Current detection" can be used to detect if the device is in the ON or OFF status.

Contact: www.hdlchina.com

Guangzhou Hedong Electronic Co., Ltd (HDL)

LCD Panel (HDL-M/DLP04.1)



The HDL KNX LCD Panel uses a high-resolution dot matrix LCD display. The buttons allow controlling and sending in a flexible and a combined way HVAC, floor heating, air-conditioning, switching, dimming, shutter applications, scenes, values and text. Each of these functions can be sent with a delay. By using special software provided by HDL, human friendly graphics can be customised by the user. The LCD panel can be also controlled by infrared and has a built in temperature sensor for temperature measuring and reporting via KNX. Each button can be locked, unlocked and triggered via KNX. Depending on the needs, separate or combined control is possible. In night mode, the button and LCD brightness can be automatically adjusted to the minimum level.

Contact: www.hdlchina.com

Guangzhou Video-star Electronics Co.Ltd.

K-Bus RS485 converter



The K-Bus RS485 converter is designed to convert RS485 protocol to KNX protocol. For intercom systems and other RS485-based building control systems. K-Bus RS485 can help to convert the system and control the KNX devices. K-Bus RS485 converter has one-way communication with a 2000V ESD built-in protection. With the simple open protocol of K-Bus RS485, it only takes the engineers a bit of time before the two different systems can be perfectly integrated and use its splendid functions.

Contact: www.video-star.com.cn

Hager

Hager Universal Dimmers for tebis KNX



Hager now also offers its innovative universal dimmer technology for tebis KNX. There are three new modular devices that can cover many common applications: TXA210AN with single output for loads up to 300 W, TXA210N with single output for loads up to 600 W and TXA213N with three outputs for loads up to 900 W. The tebis KNX universal dimmers automatically recognize the type of load and choose the appropriate dimming mode. Thus, almost all dimmable lamps including energy-saving bulbs and LEDs can be dimmed without further adjustment.

Contact: www.hager.de

Helios Ventilatoren GmbH & Co KG

KWL



Controlled ventilation units with heat recovery (KWL®) from Helios provide a healthy, pleasant temperate climate round the clock and save valuable energy. The units are now available with the innovative control system Helios Easy Controls. With the standard integrated web server and LAN connection it sets new standards in terms of user friendliness: The ventilation units can be integrated easily in the local PC network, the comfortable user surface opens in any web browser. Whether with PC, laptop, tablet or smartphone. An optional KNX module also allows the connection to a KNX building management system.

Contact: www.heliosventilatoren.com

Home Systems Consulting S.p.A.

Hsyco 3.2



HSYCO is a web-based pure HTML5 supervision server for the development of integrated control systems for KNX and other standard and proprietary environments. The new 3.2 version of HSYCO brings many new features:

- improved, native support of the KNX protocol
- a new KNX Browser for the discovery and configuration of KNX devices
- an ETS project import tool
- VoIP integration with standard SIP-based telephony systems.

HSYCO can now implement IVR features on incoming and outgoing calls, phone messaging with text to speech and interactive control of KNX devices and any other integrated system. Full Voip telephony and Intercom features can be extended to Touch PCs.

Contact: www.homesystemsconsulting.com

ICONAG-Leittechnik GmbH
B-CON.net MaxiApplet



The B-CON MaxiApplet comes with an emotive user interface to control rooms at the highest stage. Due to the simple navigation path, the user is able to create an intuitive user interface oneself. The application is usable with iOS, Android and windows devices. The connection to an existing KNX Bus is realized with the KNX OPC Server from ICONAG, which is used in a lot of projects all over the world and included in every B-CON MaxiApplet license. The main features of the MaxiApplet are the timer with eight channels, the integration of IP webcams, notification by email and the support of different protocols like KNX, BACnet and OPC.

Contact: www.iconag.com

Ingenium Ingeniería y Domótica S.L.
DMXBUS



The KNX/DMX is a communication gateway between KNX protocol and DMX 512 protocol. This device allows to regulate the 512 channel supported by the DMX protocol and executes up to 16 scenes, easily to program with the ETS software. Thanks to this device it is possible to individually regulate each DMX channel or to program a complex group of commands in a scene.

- Capacity:
- 512 DMX channels emulation.
 - Up to 16 scenes execution.
 - Programming by MicroSD card (2 GB max. / FAT16 format).

Contact: www.ingeniumsl.com

Intesis Software s.l.
New IntesisBox® KNX
– Panasonic ECOi and PACi AC gateway



Intesis presents its new gateway IntesisBox® PA-AC-KNX-64/128 for integrating Panasonic ECOi and PACi air conditioning into a KNX system. The gateway has direct connection to KNX TPI. It is available in two versions, one controlling up to 64 indoor units and another one up to 128, both allowing control and monitoring of every single indoor unit separately or all at the same time. The IntesisBox® PA-AC-KNX-64/128 setup is performed in a very easy and fast way by using the Link-BoxEIB software, which includes a specific demo project in order to help with the integration.

Contact: www.intesis.com

Ingenium Ingeniería y Domótica S.L.
DALIX



The DALIX gateway is a control interface device between DALI protocol and KNX bus. It allows the control of up to 64 DALI lights and an integrated power supply. It permits light control through other KNX devices like touch panels, pushbuttons, etc.

- Up to 64 DALI lights individual control.
- Up to 16 groups.
- Integrated DALI power supply.
- Power supply: 230 VAC.
- Power consumption: 0,5 W.
- Mounting: DIN Rail
- Size: 4 DIN modules.
- Operation: from -10°C to 55°C /
- Storage: from -30°C to 60°C /
- Transportation: from -30°C to 60°C

Contact: www.ingeniumsl.com

Intesis Software s.l.
Houseinhand 2.0:
Better than ever!



Intesis presents the 2.0 version of Houseinhand with a new and fresh user interface, better stability and improved performance. This version includes a new organization level (zone, room, device), support for multi-installation permitting to change the configuration project file, the possibility to discover new KNX/IP gateways and multi-language interface. All these features provide more flexibility and can be managed from inside the app itself. More icons for both rooms and are now available, now you can use your own pictures as icons. Furthermore, Houseinhand now also includes new devices and options. Go to www.houseinhand.com to see what's coming.

Contact: www.intesis.com

iRidium Mobile Ltd.
iRidium for KNX
– New Version 2.0



“iRidium for KNX” V2.0 is built from the ground up unlike any control automation product on the market! It turns your iPad/iPhone/ iPod Touch, Android, Mac, Windows XP/7/8 into a convenient and reliable panel for controlling the KNX system, AV equipment and Media Servers with full 2-way communication. With the help of “iRidium for KNX” V2.0 you can control lighting, climate, curtains, security systems, Audio / Video equipment and any other equipment through TCP/IP, RS232, IR. “iRidium for KNX” V2.0 brings control of Residential and Commercial Automation to a new level. Control your KNX installation & Audio / Video environment from any gadget using any graphic interfaces from any place in the world!

Contact: www.iridiummobile.net

iSimplex

**iSimplex Home Server 5
– All in One Server**



iSimplex Home Server 5 provides a single interface to control everything in a Smart Building, accessible from anywhere (web, no app install), personalizable and simple to use, providing the ultimate control experience! It now comes with an integrated Media Server (and a PBX), so you get multiple servers in one. New Mobile Media Module, watch movies and other media in any device through the home interface (like a tablet or PC), anywhere in the world! New Energy Module, access to real time consumptions by floor, division and objects in a tree graph view, define energy Tariff plans. New Global Cache integration, control any equipment by IR or RS 232. Build remote controls easily and much more.

Contact: www.isimplex.com

Jung

KNX presence detector



The new KNX Standard or Universal presence detector impresses by excellent detecting properties for mounting heights up to 5 m, compact design with built-in bus coupling unit as well as by the capability of presence-based constant light control. The 360° detection angle may be divided into three 120° portions each that may be enabled individually. Additionally, the Universal device has five functional blocks that operate independently of each other and to which the three PIR sensors may be allocated. Each functional block may be configured as desired to be used as a presence detector, ceiling automatic switch, or in signalling mode. The unit may be optionally set up and operated using an IR remote control.

Contact: www.jung.de

Lifedomus

Design Studio



Lifedomus system has a revolutionary multi patented graphical user interface. Lifedomus is the universal home automation system. Its “Design Studio” interface can be customised with no limit, by every user / installer. The usability and the graphical features can be adapted without any coding. Lifedomus is also multi-protocol (including KNX), multi-users, multi-platforms (Windows, MacOS, iOS, Android) and multi-uses (home automation and multimedia). Lifedomus enables all home automation uses: security, comfort, energetic analysis, multimedia, multi-room audio and video, universal remote control, etc.

Contact: www.lifedomus.com

LOYTEC electronics GmbH

**LINX-220/221
Automation Server**



LOYTEC programmable LINX-220 and LINX-221 are KNX automation stations with I/O expandability and integrated visualisation for room and building automation. The high-performance L-INX Automation Servers support KNXnet/IP and optionally KNX TPI. For the integration of other bus systems interfaces to BACnet and Modbus are available. If KNX TPI is not required, an M-Bus level converter can be connected alternatively. An integrated OPC XML-DA Server represents all data points as OPC tags. The integrated visualisation is made visible by the provided LWEB-800 software (.NET application) or a WEB browser.

Contact: www.loytec.com

MBS GmbH

**Compact KNX/BACnet
Gateway**



At ISH 2013 MBS presents a new KNX/BACnet Gateway. This device offers various options to connect KNX networks to BACnet. Beyond data-exchange of actual values and set-points the communication may be setup for change-of-value reporting. Additionally the gateway supports BACnet alarming, scheduling and trend-logging as well as device management. The power supply is variable from 12 - 24 V AC / DC. The integrated web-server assists in the configuration process.

Contact: www.mbs-software.de

MDT technologies GmbH

**AMI/AMS-1216.01
Actuator w / True RMS
and meter function**



The new generation of AMI / AMS series contains a special CPU for True-RMS current measurement. This allows 2000 measurements in 500 ms with +/-2 % accuracy of the measuring value. The currents are measured from 10 mA to 20 A and the actual used power can be calculated with a factor to W/kWh. The metering function counts Wh/kWh. The total consumption of all 12 channels is also available. The actuator uses a large application with an operating hour meter per channel. The actuators are available with 16 A C-load 140 µF (AMS) and 20 A C-load 200 µF (AMI) with four, eight and twelve channels.

Contact: www.mdt.de

MDT technologies GmbH

SCN-P360K4.01

Presence Detector w/ wo/ constant light



The new presence detectors with high resolution lens and four pyro sensors detects the smallest movements. With day/night control it is possible to use different objects: for example during day 100 % light and during night 30 % light or send an alert message only. The sensitivity for standby (medium) and presence (high) can be set individually. The four sensors can be dedicated to two zones (e.g. dining room / living room). A new function will ignore a passing person in the corridor. A proportional master-slave control is used for constant light intensity to control up to three light-bands (window, middle and wall).

Contact: www.mdt.de

NetxAutomation Software GmbH

Shutter Control System 2.1

Shutter Control System



For building complexes with a high number of shading elements, NETxAutomation developed special software for the intelligent control of shutter elements.

- A shading server takes over the duties of shading calculation and optimal control
- A shading manager provides an interactive user interface to control and monitor the various server tasks
- Central monitoring and logging of shading components
- Sun tracking control of the slats
- Optional 3D model for consideration of external shades on shutter element

Automatic safety and maintenance operations are considered.

Contact: www.netxautomation.com

Schneider Electric

KNX Metering Gateway



The new KNX Metering Gateway is the user friendly interface for comprehensive consumption analysis by Schneider Electric. It combines the functionality of the Modbus open standard with KNX intelligent building control. It measures values from up to 10 Schneider Electric meters with a Modbus interface and connected SIM modules for recording gas and water consumption. The interface can be integrated into the KNX Energy Management system. It features pre-installed ETS templates with the 20 most frequently needed values to simplify the configuration. The KNX Metering Gateway is the Modbus RTU master and is supplied via the KNX bus – the easiest way to connect intelligence and efficiency.

Contact: www.schneider-electric.com

merten

KNX Energy Meter



The new KNX energy meter from Merten allows you to measure energy consumption in homes, small offices or businesses and to reduce it simply. The device also collects energy usage data from individual appliances or items, such as washing machines, refrigerators, or IT server compilations. Up to three channels are available for monitoring purposes, with a maximum load of 16 Ampere on each. The KNX Energy Meter measures the energy consumption of the individual channels as well as the total usage – via a touch panel the values can be called up at any time.

Contact: www.merten.de

preussen automation

PicSwitch KNX



Ventilation, underfloor heating, music and a variety of individual tasks can be controlled by the PicSwitch KNX of preussen automation. With the new, intelligent wall switch the user can control up to 28 different functions. Integrated into the PicSwitch KNX is an infrared receiver, so that the switch can also be remotely controlled. Because of its great variety of applications, the PicSwitch KNX is suitable as a central command unit for all products of preussen automation.

Contact: www.preussen-automation.eu

Siemens AG

GAMMA flush-mounted actuators



The new room automation system includes actuators for the control of lighting and shading. This comprises modules for use with the room automation boxes AP 641 / AP 118 and flush-mounted devices with or without mounting bracket. All products offer the same functionality and same configuration choices. The actuators are ideally suited for use with buttons installed close to the respective function. Ease of installation also includes wiring, which means that the new double plug-in terminals are capable of accommodating single and very thin wires, with no need for using ferrules.

Contact: www.siemens.com/gamma

Siemens AG

GAMMA for flexible room operation across all disciplines



The versatile room operating unit UP 227 controls and switches all room functions required for heating, ventilation, air conditioning, lighting, shading and electrical devices. Intuitive operation and programmable scenes offer ease of use while minimizing the effort required for installation and configuration. The UP 227 has been designed for energy efficient applications such as temperature or constant light control and helps reduce the thermal and electrical energy consumption per room. Also, the room operating unit is suited for use in connection with the DELTA frame program.

Contact: www.siemens.com/gamma

Siemens Schweiz AG

Room thermostats



The RDF600KN room thermostat for flush mounting has been designed for use in the field of heating / cooling with fan coil units and heat pumps. It offers compact solutions with direct connections to HVAC components such as valves, sensors or switches. The product is very versatile and suited for 2- and 4-pipe systems. It features two multifunctional inputs and a selectable output signal for simple on / off or modulating (3-position) valves. Also, the thermostat excels in ease of installation and modern design.

Contact: www.siemens.com/room-thermostats

Steinel GmbH

Presence Control PRO IR Quattro SLIM



The ultra-slim Presence Control IR Quattro SLIM presence detector from Steinel impresses architects and interior designers alike. Measuring just 4 mm in height and providing a square detection footprint of typical room shape, the retina lens with hexagonal Fresnel structure reliably identifies the presence of persons in a room. The presence detection zone covers a true 16 m². Twilight threshold and teach mode for memorising ambient brightness are selected by the remote control.

Contact: www.steinel-professional.de

Siemens Schweiz AG

Communicating flush-mounted sensors



Siemens extends its Symaro range of products by launching communicating flush-mounted sensors. Thanks to their modular design, the sensors are capable of acquiring any combination of temperature, relative humidity and CO₂. Also, owing to the built-in control functions for each of these measured variables, actions can be taken to ensure the desired room climate at all times. All models feature two binary inputs and can handle signals from a passive extra temperature sensor. A LED on the sensor indicates the current indoor air quality.

Contact: www.siemens.com/symaro

Somfy

EnOcean integrated in KNX through Somfy



Using Somfy's new radio card, EnOcean signals can now be transferred also to a KNX bus. With very little effort, sun protection, lighting and other applications can be controlled battery-free and without wires. The card can at any time be slotted into and integrated with a Somfy KNX motor controller. On activating the radio function, the system does not require an additional physical KNX address. Animeo can be integrated in all Somfy motor controllers, no matter whether for 230 V motors, 24 V motors or 24 V motors with incremental encoder. The new Somfy radio card can be combined with the battery-free, EnOcean radio switch module PTM 200 and PTM 210.

Contact: www.somfy.de

Steinel GmbH

sensIQ S KNX



With 1,360 switching zones, the sensIQ S KNX is a user friendly sensor for all applications on and in the building with precision-scalable detection in three directions and a coverage angle of up to 300° from a 180° angle of aperture, including coverage directly below the sensor. A lens system comprising four pyro sensors with six detection levels for long-range coverage and five sneak-by levels ensures detection quality in extremely high resolution. Functions, such as twilight threshold, stay-'ON' time, soft light start or holiday function, can be selected by ETS or remote control.

Contact: www.steinel-professional.de

STG-BEIKIRCH GmbH & Co. KG
Synergies of both worlds



The new KNX interface card for the modular control panel MZ2 of STG-BEIKIRCH and the extended Gira server App for iOS devices allow communication of MZ2 and Gira FacilityServer respectively Gira HomeServer for visualisation and control of natural ventilation via window automation with the Gira App on iPhone and iPad. Simultaneously, smoke and heat extraction is visualised using an easily understandable interface and incorporated into a suitable system for facility managers and end users, without compromising safety standards and regulations, since all security functions operate independently from the comfort functions.

Contact: www.stg-beikirch.de

T2M2
KNX Touch PC
T2 Edition3 I02R



Elegance meets value. The successful t2 Edition3 PCI02 Wide is now also available with a resistive touchscreen. With a single instead of a multi-touch screen the product offers high-quality at an even more attractive price with the same design and finish. Equipped with an Intel ATOM processor and the latest LED displays the power consumption is kept to a minimum. The connection to the KNX bus is solved with an integrated USB interface as option or can be done via a KNX/IP interface. All major KNX Visualisations that run on Windows XP/7 can be used. All Touch panels are fanless. Speaker and microphone are integrated.

Contact: www.t2m2.de

TAPKO Technologies GmbH
KAlstack for Renesas



KAlstack is the main software component of KAI and provides the complete functionality for KNX devices. Embedded system designs that employ KAlstack and the Renesas RL78 microcontroller family gain access to the powerful platform KAI for KNX enabled bus devices. For example, the RL78/G13 microcontroller has high processing performance while delivering the lowest power consumption in its class. Up to 32 MHz CPU clock operation are possible. Built-in features such as a reset circuit, a low voltage detection circuit, a watchdog and flash with background operation function help to lower the total cost of building a KNX device and contribute to more compact size and lower power consumption.

Contact: www.tapko.de

TAPKO Technologies GmbH
KAlstack for
STMicroelectronics



The combination of KAlstack and the Ultra-low-power platform for 8-bit (STM8L) and 32-bit (STM32) MCUs from STMicroelectronics facilitates the access of embedded systems to the platform KAI for KNX enabled bus devices. The EnergyLite™ platform from STM provides functions like POR, BOE+PDV, IWDG, RTC, LSE with automatic clock gating, off for Flash and fast start up to decrease power consumption. Operating Voltages from 1,8 V are sufficient. More security and safety functions like on chip memory protection, CRC32, dual watchdog, anti-tamper and other enrich the field of use. KAlstack is the main software component of KAI and provides the complete functionality for KNX devices.

Contact: www.tapko.de

tci GmbH
contatto



With **contatto**, tci realizes in-house communication and building control via KNX as an integral two in one solution on one touch panel. **contatto** provides audio and video communication over VoIP/SIP and video streaming. Equipped with **contatto**, the touch panels **ambiente**, **mura**, **amena** and **iBiento** become high-quality intercom systems. Besides door communication and monitoring with alerts, even room-to-room communication can be fully integrated into the building control. In addition to standard webcams, IP-based door substations of leading manufacturers can also be used. With **contatto**, KNX controlled buildings are even safer, more comfortable and more effective.

Contact: www.ambiente.de/en/550

tci GmbH
mura I6W-GT



An exclusive design and a large 16" multi-touch display at 16:9 characterize the panel PCs **mura I6W-GT** of tci. The bright display with continuous genuine glass surface shows sophisticated visualisation in razor sharp true high definition. Operation by multi-touch ensures a special comfort as well as the integrated microphone and a speaker with echo cancellation for hands free intercom. The connection to the building automation is done via KNX or Ethernet. Thanks to the shallow installation depth the **mura I6W-GT** can be integrated even in rooms with limited proportions. With the optional plaster-in housing, a flush-fitting installation is possible.

Contact: www.ambiente.de/en/520

Theben AG

8-channel KNX time switch with yearly and Astro program



Theben presents the new quartz 8-channel KNX time switch TR 648 top2 RC KNX: weekly, annual and Astro programs are programmed via the onscreen text-based instructions on the device, via the KNX bus or on a PC using the intuitive OBELISK top2 software. Transfer the finished program to the time switch via the OBELISK top2 memory card. Time synchronisation can be performed via external DCF77 or GPS antennas. The integrated holiday database with bank holiday adjustment also guarantees reliable control on moveable holidays such as Easter and Whitsun.

Contact: www.theben.de

Theben AG

KNX twilight switch LUNA 134 KNX with 10 switching channels



Theben presents the new KNX twilight switch LUNA 134 KNX with ten universal channels, where up to three brightness sensors can be connected. All parameters, including brightness, thresholds or delay times, can be configured on the device using four push buttons or – as usual – via ETS. The four threshold channels and six logic channels, which are connected to the switching channels in ETS, are new. All settings can be protected against unauthorized access via a PIN code. The hysteresis provides different settings to avoid faulty operation.

Contact: www.theben.de

tisco GmbH

Control4 – KNX Integration Suite



Software based visualisation with integrated controls for Android, iOS and Windows. Graphical representation for all KNX Objects and optimized support for KNX HVAC control with flexible schedules and comfort settings. Easily combinable multimedia scenes and intelligent wakeup are user configurable. Presence simulation, smart blinds control and RGB Light Control via C4 Apps. Smart Metering App is in development. Time Master via NTP and programmable logic functions for advanced installations.

Contact: www.tisco.at

Tokka Sp. z o.o.

KNX Paradox interface



The KNX Paradox PEVO96 interface is designed to visualise 96 states of the alarm zones from the security systems of the company PARADOX in KNX. Status information, coming from the zone of the alarm system, whether the line is open, closed, faulty or in alarm mode, can be used by ETS group objects for safety purposes or for the control of e.g. lighting, shutters, heating etc. The interface has four holes in the corners on its printed circuit board, therefore assembly of this module in alarm boxes is easy for the installer. For RS232 connection of the interface to the a PARADOX alarm system, a PARADOX integration module PRT3 is needed.

Contact: www.tokka.pl

Tokka Sp. z o.o.

KNX NuVo gateway



Tokka now offers a solution for home and commercial building automation users who are interested in control from KNX audio signals coming from NuVo Central Process Units – Grand Concerto and Essentia E6G. The KNX NuVo gateway allows the end user to independently control each of eight audio signal distribution zones with KNX. In other words KNX sensors like e.g. push buttons, movement or presence detectors etc. can be used to control the audio zone. Change of the source, song or volume are some of the functions which are available in the ETS application of the device. For the connection of the gateway to the NuVo CPU, a RS232 terminal is used; the device is equipped with a velcro strap for easy assembly.

Contact: www.tokka.pl

VANTAGE EMEA nv

Vantage KNX interface



The KNX Interface provides a gateway to the KNX world and allows KNX users to benefit from the power of Vantage systems. The simple and intuitive interface provides control and feedback from all KNX based devices to any Vantage touchscreen, iPad, iPhone, Android device, etc. The interface communicates with the Vantage main controller over a network connection. On the KNX side the interface is provided by a KNX bus connector. Fully integrated projects are the mission of Vantage and the basic premise is to provide a system integration platform. Vantage has always aimed to be open to any external system available on the market and to be able to communicate with external systems bi-directionally.

Contact: www.vantage-emea.com

Viatron GmbH

Autrix: Music-distribution-system with integrated amplifier – modularly expandable



Easy installation / direct KNX connection. 8 x volume control via dimmer object: separate Datapoints for Control and Feedback (relative, value, status). Input signals can be selected by Datapoint (1byte) or stepwise (DPT 1.007). Central functions, MasterMute, ZoneMute and Power on/off are available by additional KNX Datapoints. The Autrix MultiRoom System can be used in private homes as well as in commercial environments. Installation: 19" or flat wall mount.

Contact: www.viatron.de

Visam GmbH

VISAM Touch Panel



With the VTP series, VISAM GmbH is presenting a very flexible and feature-rich solution for building automation. Besides many other designs, the elegant VTP-AX models are standing out with a high resolution 15" or 21" TFT display. They are equipped with a foil or glass touch screen by customer desire and can be mounted in or on the wall in portrait or landscape format. The functions and the user interface are freely customisable with the included SCADA software. The software also enables automation beyond function and manufacturer borders. Besides KNX, it supports about 200 different remote systems and protocols.

Contact: www.visam.com

Weinzierl Engineering GmbH

KNX BAOS 870 (REG)



With the KNX Serial Interface BAOS 870 Weinzierl Engineering provides a simple integration solution for non-KNX devices. Designed as a RS 232 interface, the new KNX Serial Interface BAOS 870 uses the proven FT1.2 protocol as message format and can thus be used as a programming interface for ETS. Moreover, the device supports the BAOS protocol for accessing data points. This allows non-KNX devices to be fully integrated into a KNX network. Free SDKs, a demonstration tool as well as an ETS entry with 250 group objects are available. Furthermore, individual ETS representations for OEM versions can be created.

Contact: www.weinzierl.de

Vimar SpA

New KNX Touch Screens



The new Vimar three-module and Full Flat 4.3" touch screens offer a simple control of KNX installations from a single point. Combined with the elegant Eikon Evo cover plates, the new flush mounting touch screens have a sophisticated, exclusive design, which adds an extra touch of class to any setting. With an NTC probe input and integrated KNX connectors, these new devices can easily be configured via a serial connection using Vimar software, directly importing the ETS project. The graphic customization of the supervision pages – using icons and multilingual descriptions – and the possibility to choose the display screen make these Vimar touch screens ideal for monitoring KNX automation systems in any setting.

Contact: www.vimar.com

Warema Renkhoff SE

**Warema climatronic®
KNX Weather centre**



This device set is a KNX central control unit. Control programs for sun shading systems, windows and lighting are pre-configured – for up to 64 control channels, 16 scenarios and 1,200 actuators:

- monitoring of wind speed, ice, precipitation
- slat tracking relative to the sun position for glare control and daylight utilization
- temperature, differential temperature, dawn/dusk control
- slat control
- automatic clock

Manual control or positioning can be made at the control panel. Scenes can assign descriptive names. Lighting can be dimmed. Weather data can also be transferred to third party devices. Parameters can be backed up on an SD card.

Contact: www.warema.de

Weinzierl Engineering GmbH

KNX RF USB 2330 Stick



Radio configuration now using ETS: with the introduction of the KNX RF USB 2330 Stick Weinzierl presents an essential system component for the new radio system within the KNX Standard. With the upcoming version of ETS, KNX radio components can be put into operation for the first time like devices for twisted pair or power line. The KNX RF USB Stick 2330 is the first KNX USB wireless interface in the practical shape and design of a USB Stick. It already supports all protocol extensions of the KNX Standard for ETS integration. With this stick not only wireless devices can be put into service. Via a KNX TPI/RF coupler also wired KNX devices can be configured.

Contact: www.weinzierl.de

Zennio Avance y Tecnología s.l
MAXinBOX8



KNX actuator MAXinBOX8 controls shutters, lighting and climate. It includes eight relay outputs that can be configured either as individual outputs or shutter channels. MAXinBOX8 outputs have 16 A relays and support capacitive loads up to 140 µF. It includes the option of manual operation and a status indicator for each output. Its Test mode allows checking each output without a previous application download. MAXinBOX8 includes an internal logical module with ten logical functions, which allows the integrator to offer projects with additional versatility. It does not need ancillary power supply.

Contact: www.zennio.com

Zennio Avance y Tecnología s.l
ZPS-I60MPA KNX power supply 160mA plus 29VDC ancillary power supply



The new KNX power supply ZPS-I60MPA replaces the phased out Zennio's ZPS-I60M KNX power supply in order to include ancillary power supply in this new product. It consists of both KNX Power Supply 29 VDC 160 mA and an additional ancillary power supply 29 VDC, independent of the KNX bus, to supply up to 250 mA (KNX + Ancillary) total current. Besides, it includes a green LED as operation indicator and incorporates overvoltage and short-circuit protection. ZPS-I60MPA becomes the smallest KNX power supply to fit in low cost installations where an ancillary 29 VDC supply is necessary.

Contact: www.zennio.com

ETS for Beginners and Experts: Two new flyers for KNX!

ETS4 for Beginners – 8 Steps to Success

In this flyer the ETS4 Beginner learns all the necessary steps for a successful installation of the ETS 4 and the creation of a new project up to the adjustment of the product parameters as well as the project download and the proper ending of the project.

ETS4 for Experts – New ETS4 Functions, improved Workflows

In this flyer the ETS4 Expert learns basic information to increase the optimization for the user's work flow and the advantages of the new functions, which you couldn't find in the ETS3.

The Flyer is now available for you. You can download it from the KNX website.



For more information see:

Link: <http://www.knx.org/downloads-support/downloads/>

KNX Association
 De Kleetlaan 5 Bus 11
 B- 1831 Diegem-Brussels
 Belgium

General contact:
 Tel.: +32- (0)2 - 775 85 90
 Fax.: +32- (0)2 - 675 50 28
 E-mail: info@knx.org



National Groups



Crowded foundation of KNX Argentina

On October 5, the constitution of Latin America's second KNX National Group – KNX Argentina – was adopted. The event took place at the AADECA Congress in the city of Buenos Aires. A total of 20 companies, two training centres and a university joined the new National Group. Posts on the Group's Executive Board were filled during formal elections which took place at the opening ceremony. The results were as follows: President: Jose Daniel Gomez (Jung); Vice President: Paul Thierry (Merten); Secretaries: Matthew Ramos and Augustine Abdala (both from the CTF Training Centre). The main objective of the new National Group is to promote the KNX technology in Argentina,

promote the use of the standard, and support the continuous exchange of information among its members. Furthermore the National Group will coordinate marketing activities, and ensure the correct

maintenance and use of KNX technology in the country.

Contact: agustin.abdala@knxargentina.com and mateo.ramos@knxargentina.com

Web: www.knxargentina.com



All founding members of the National Group KNX Argentina following its establishment.

KNX, the road ahead in Australia

Isolated for millions of years, Australia is one of the oldest continents on earth. Now one of the world's powerhouse economies exporting minerals, agricultural products, services and technology, Australia, like many Western countries, faces dramatically rising energy costs. Energy efficient buildings are increasing in importance and KNX is gaining in acceptance in Australia; however, it still faces the challenge of a country used to local proprietary systems for home and building automation.

The activities of the National Group have focused on educating the market, which is now embracing the KNX system as the recognised international STANDARD for home and building control. Members of the KNX National Group have all individually contributed to the "KNX road" and during 2013 a programme of support for these activities will

assist in the spread of knowledge and experience of KNX. 2013 looks to be another exciting year for the development of KNX in Australia

through training, events, exhibitions and projects.

Contact: info@knx.org.au

Web: www.knx.org.au



Members of KNX Australia at the KNX booth

KNX – technology that connects

On November 12 2012, the Austrian KNX National Group held an event designed to help people forge connections. It was called “KNX – Technology That Connects”, and took place at the ORF Centre – the radio studios in Graz. Following a detailed tour of the studios and technical facilities at the ORF Centre, the more than 80 participants attended a number of enlightening talks, naturally focusing on KNX. The first was an introduction by KNX Austria’s spokesperson Ernst Windhager who presented key facts about KNX, which was followed by insights on the subject of the KNX City from Siegfried Gaida, CEO of Thermokon Austria. The next presentation, by Arnold Stengg of the engineering office of the same name, was a particular highlight, and was received with great interest. In his talk he looked at the energy

that can be saved with KNX. He explained the issues in very simple, accessible terms with the help of real life examples. The final presentation, by Kle-mens Schwarz of AV Stumpfl,

considered how multimedia is featuring more and more in KNX applications.

Contact: knx@mrpr.at
Web: www.knx-austria.at



Studio 3 at the ORF Centre in Graz, Austria, full of attentive participants.

KNX Belgium event attracted many visitors and much attention

On September 6, KNX Belgium held an event at De Nayer Instituut in Sint-Katelijne-Waver. This KNX Certified Training Centre and KNX Scientific Partner was the perfect location for the event, which was attended by more than 250 participants from Belgium. After an introduction to the activities of KNX Belgium and

KNX Professionals, Miele and Belgian KNX Member Renson informed the public about their innovations and energy efficient solutions. The presentations concluded with an introduction to ETS 4.1, the new ETS Apps, and the KNX eCampus. After the presentations, the ten manufacturers of KNX Belgium all exhibited their latest prod-

ucts at small stands. Participants could visit these stands while enjoying a drink and snacks, or network with each other. Because of the great success of this event, KNX Belgium has already decided to organise a similar event on September 5. More pictures can be found on the KNX Association Facebook page.



Contact: info@knx.be
Web: www.knx.be



Showcasing KNX devices in the exhibition area at the event



The auditorium at De Nayer Instituut in Sint-Katelijne-Waver (Belgium)

Founding of the 1st KNX National Group in Latin America: KNX Brazil

On Wednesday, August 8 2012, at the Predialtec 2012 exhibition in Sao Paulo, the KNX National Group Brazil was founded. This prestigious event was attended by more than 20 visitors from ten companies. Elections were held to the Group's Executive Board, with the following results: Rogerio Ribeiro (Schneider Electric) was elected as President; Gustavo Vazzoler (ABB) became Vice President; and Alex Frazatti from the Home Automation Association AU-RESIDE was elected Secretary. Apart from the founding of the new National Group, KNX also participated in the Predialtec 2012 exhibition itself, with Heinz Lux delivering a speech to more than 100 delegates at the Habitar Congress 2012, highlighting the benefits of the KNX technology.

Contact:

tecnico@areside.org.br

Web: www.knx.org.br



Visitors and KNX Brazil members at the KNX stand (event: Predialtec in Sao Paulo)



All of the founding members at the launch of KNX Brazil

Successful participation of KNX China at SIBT exhibition in September

From 20 – 22, September KNX China – made up of Chinese KNX manufacturers and major system integrators – participated in the Shanghai Intelligent Building Technology exhibition. On all three days of the event, the KNX China stand was crowded, with large numbers of visitors stopping by and demonstrating consid-

erable interest in KNX. The KNX stand became a focal point for the entire exhibition hall.

The 3rd “KNX Technology and Application for Home and Building Control” forum was held in parallel to the fair on September 21; here the new KNX City concept was presented. In addition experts

from the KNX Association presented the advantages of KNX, and showed how to combine KNX with a smart grid. This event was a great success thanks to the support of local KNX manufacturers and system integrators, who shared their experience of developing KNX products, applications and solutions.



Contact: info@knxchina.org

Web: www.knxchina.org



Joint KNX stand at the 6th international Shanghai Intelligent Building Technology exhibition



Heinz Lux at the 3rd KNX Technology and Application for Home and Building Control forum.

KNX firmly on the curriculum

Since the 1990's, when KNX was introduced to the Danish market, the standard has been on and off the curriculum at the technical schools that qualify students to become electricians. Changing educational

policies and directives have made it difficult to establish a solid foundation for the teaching of the standard. Luckily, times change and from middle 2013, a specialised course in KNX will become compulsory

for those taking Building Automation as part of their electrician studies.

"I am convinced that the school's official recognition of the KNX standard will cement the position of KNX in



Denmark. Furthermore, it is my hope that other technical courses will follow the example of the electrician course and incorporate KNX into their timetables. I am very pleased that we have succeeded in being standard-bearers for KNX in the education system," says Lillian Andersen, chairwoman of the Danish KNX National Group.

Contact: info@knxdenmark.dk
Web: www.knxdenmark.dk

KNX, an unstoppable winner

Once again, KNX Finland has received an award at the annual Electrical Contractors Days, which were held in Tampere from November 21 – 22, 2012 and attended by more than 300 participants. The event was organised by the Electrical Association Engineering Education and Research Foundation, which took the opportunity to present two awards:

The first award was for those who helped to develop the electrical trade, and was won by KNX Finland ry in recognition of its effective work in developing the building automation and e-education sector. KNX Finland ry actively works with schools to incorporate training in KNX bus technology into their curricula, and so far has worked



Managing Director of SLOOy Mika Höijer, KNX Finland ry Executive Director Johan Stigzelius and Chairman of the Board Harri Liukku at the award ceremony.



with more than 25 secondary schools across the country. The programme is unique and has raised the market's awareness of, and competence in, automation solutions. The award was accepted by KNX Finland ry's Executive Director Johan Stigzelius and Chairman of the Board Harri Liukku. The second award, also related to education, went to Professor Liisa Halonen of Aalto University in Finland.

Contact: info@knx.fi
Web: www.knx.fi

KNX Technical Workshop

On Wednesday November 28, KNX France in collaboration with KNX Association welcomed more than 40 participants for its KNX Technical Workshop in Paris.

After welcoming the participants, Mr. de Carné as President of KNX France gave the floor to Joost Demarest, Chief Financial Officer at KNX, to inform the participants about the unique advantages of KNX and the last year's growth figures of KNX worldwide. Mr. Delachat from ABB and Mr. Napar from Siemens made a duo presentation on the significance of KNX in the French market. Mr. Gossé of the company Tapko, a well-known KNX system component/stack service provider, rounded off the morning session with a de-



The picture shows a full conference room carefully listening in on the topics being presented.

tailed presentation of aspects to consider when starting a KNX product development. The audience profited from the fact that Mr. Gossé is one of the persons involved in the

early developments of the KNX RF system to ask questions on the design decisions of the current solutions as well as those that are currently in the pipeline: these are expect-



ed to materialize in concrete products and KNX RF support in ETS version 4.5 in the middle of next year.

In the afternoon, Joost Demarest again went on stage to inform about the procedure to become an ETS App developer, after which Mr. Le Men from Newron-Systems finished the conference with a presentation on the forthcoming ETS App, MooV 'n' Group, developed by his company.

Contact: contact@knx.fr

Web: www.knx.fr

Technical Colloquium is a major success

KNX Germany's 3rd Technical Colloquium was held on November 9 and attracted around 120 guests, system integrators, installers, scientists and IT consultants.

The motto of the Colloquium was "Building automation means KNX – security for the future". Participants attended engaging presentations on technical topics, followed by a lively panel discussion with high-calibre panelists, and took part in heated debates about the new challenges that KNX faces. For example: the technical challenges posed by the "energy turnaround", the expansion of the KNX protocol to permit secure data transmission, and assessing the importance of security-relevant fields such as smart meters, controllable loads, and service providers.

Overall, the conclusions of the 3rd Technical Colloquium were KNX is on the right track, and KNX technology is gaining acceptance worldwide.



The 120 enthusiastic participants in the large conference room at the ZVEI.



For more details and to see the presentations, visit www.knx.de.

Contact: knx@zvei.org

Web: www.knx.de

KNX India – Active from the very beginning

In April 2012, the third-biggest country in Asia became part of the world of KNX with the founding of KNX National Group India. After the foundation of the group, members got active right away and organ-

ised workshops all over India, participating in ET ACETECH (Mumbai), one of the leading exhibitions in India. Interest in KNX Training also grew, which led to the setting up of new KNX Training Centres

and the training of new KNX Partners. For 2013, the goals of this KNX National Group have been set high, due to the large potential and enthusiasm of all members of KNX India. Upcoming activities are certain to raise awareness of KNX in one of the world's biggest emerging markets.



Contact: info@knx.in
Web: www.knx.in



KNX India participating at ET Ace Tech; First fair for KNX India



KNX Training Workshop at Schneider Electric

KNX day in Milan

Despite severe winter conditions, nearly 100 participants made their way to the KNX Day organised by KNX Italia on December 14 in Milan.

The conference started with five parallel sessions:

- A session on KNX training, with a focus on general information about ETS4 and the new ETS App concept;
- A KNX Championship, run in parallel for two target groups: KNX newbies and KNX partners;
- A session providing detailed technical information about the KNX system;
- A session on the issues to consider when designing a KNX project;
- A session providing tips on the best ways to market KNX within projects.



Two candidates testing out their skills during the KNX Championship, assisted by Cristiano Carli Ballola of Schneider Electric.



Renato Ricci leading the KNX training session.



After the sessions, participants were invited to attend the second Italian KNX Award ceremony, in which local integrators and installers received prizes in several categories in celebration of their work.

The evening was rounded off with a buffet – which provided guests with opportunities for networking and a burlesque show.

Contact: segreteria@konnex.it
Web: www.knx.it

Three seminars, three exhibitions and one forum in just one year

Since its foundation in February 2012, KNX Korea has been tremendously active. Over the course of this year, KNX Korea has organised several of its own events and participated in leading Building Automation fairs in Korea. The outcome did not disappoint: 60 new KNX partners, even though there are only two certified KNX Training Centres in Korea. KNX Korea's many activities raised awareness among manufacturers, many of whom became KNX members and started developing KNX solutions for the local Korean market. In 2013, KNX Korea will focus on becoming the leading association in the field of home and building control in Korea. Expect even more; the future looks very bright.

Contact: info@knx.or.kr
Web: www.knx.or.kr



KNX Korea at the Smart Home / Building Show



Focusing on KNX solutions

KNX Luxembourg took part in three important trade fairs in the country last year.

The first of these, early in the year, was the second ever Luxembourg "myenergy days", which is becoming a key event in the economically vibrant Euroregion of SaarLorLux. Focusing on energy upgrades to existing buildings, it brings together a wide range of tradespeople, manufacturers, wholesalers and service providers from this field.

In the late summer, the 25th Jubilee edition of Oekofoire took place, which attracts a large number of visitors interested in eco-friendly living and construction.

This was followed by the 2012 "Autumn Fair", where KNX Luxembourg had a stand in the pavilion of the Luxembourg Chamber of Crafts.

The group ran a KNX competition, which revealed that building owners are already very familiar with the KNX technology. Many tried their

luck at winning an ETS4 Lite licence or an iPod, to help them get to know KNX even better! In addition, so-called "after-work exchanges" gave a large number of KNX Luxembourg members and tradespeople

the opportunity to demonstrate their specialist knowledge and possibly win an ETS4 Professional licence.

Contact: info@knx.lu
Web: www.knx.lu



KNX Luxembourg NG President Marco Zenner (right) and Vice-President Gérard Scheuer ready to assist visitors interested in learning about KNX.

KNX Middle East founded

Dubai, was the first step in the KNX Association's drive towards an increased focus on the markets of the Middle East. The Association not only participated in The Big 5 – the leading building and construction show in the region – but also founded the “KNX National Group Middle East”. From the Group's 15 founding members, Tarek Zakaria of ABB was elected as President, and Jean-Baptiste Plagne of Schneider Electric and Suhel Rashid of Siemens were elected as Vice Presidents. Immediately following its foundation,



KNX Event: the 1st Middle East Forum of KNX Technology and Application



the new KNX National Group demonstrated its capabilities at the first Middle East forum, which was attended by 200 participants from all over the Middle East.

Contact: info@knx.ae

Web: www.knx.ae

KNX New Zealand founded

In July 2012, the furthest National Group from Europe was founded: KNX New Zealand. The members of the new National Group who participated in the foundation meeting were: Brian McKenzie (Ideal Electrical), Leo Peng (Infortek), Greg McNaughten (Future

Proof Electrical), Ulrich Frerk (Space Automation), Andrew Garland (Ideal Electrical), Bobby Merai (ABB) and Paul McMullen (Siemens).

Elections were held at the foundation meeting, with the following results: Ulrich Frerk was voted President, Greg

McNaughten Vice President, and Bobby Merai Secretary. A Treasurer (Leo Wong) and Board Members (David Procter and Andrew Garland) were also elected.

Web: www.knx.org.nz



Founding members of KNX New Zealand.

Oosterberg and TU are first KNX Wholesaler Partners in the Netherlands

Oosterberg and Technische Unie have become the first companies to join the KNX network in the Netherlands as KNX Wholesaler Partners. By joining the Group, both of these wholesaler businesses are making a clear statement to the market that they are active in home and building automation and that they want to play an important role in expanding this growing market. The market for home and building automation is, despite the crisis, clearly growing. KNX Netherlands not only of-



fers wholesalers who become members of the network a vote in electing members to its Executive Board, but also the possibility of participating in the network meetings of KNX Netherlands.

Contact: info@knx.nl
Web: www.knx.nl

Foundation of KNX Userclub Norway

KNX Norway founded the Norwegian KNX Userclub on October 19 2012 at Brakerøya in Drammen. Members of this new association, which is linked to the KNX National Group Norway, come from different sectors and include architects, electrical designers and system integrators. At

the successful founding event, 30 companies joined the new KNX Userclub, and the Executive Board was elected. From now on, KNX Norway and the KNX Userclub will work together to raise awareness of KNX in the country. As their first activity, the members of this new association

will collect information about the KNX technology, KNX solutions and KNX products, and this will be uploaded to an open online platform to give all members access to key topics, enabling KNX professionals in the Norwegian market to take their skills to the highest possible level.



Contact: info@knx.no
Web: www.knx.no



Founding members of the new KNX Userclub Norway

Seminar “How to boost your business with KNX” held in Lisbon



Delegates attentively listening to the presentation held by Casto Canavate from KNX International.

As had been done in quite a number of countries in the recent past (including Sweden, Finland, Italy, ...), on November 22 2012, KNX Portugal had the honor of hosting in Lisbon the one day seminar

entitled “How to boost your business with KNX”, organised in close co-operation with KNX Association. The event in Portugal was attended by more than 40 participants, including members

of the local National Group but also representatives from universities and potential new international as well as national members.

Casto Canavate and Joost Demarest, as representatives of



KNX International together with Mr. Ribeiro da Costa, President of KNX Portugal, highlighted the advantages of KNX, showed the remarkable growth figures of the KNX system in the last years in Portugal and the world and gave detailed insight in what needs to be considered when developing a KNX compatible product and an ETS App.

Two local delegates (OCRAM and Instituto Politécnico da Guarda) gave presentations on how they developed their business with KNX in the area of air conditioning respectively by the development of a KNX application for Android.

Contact: rhcarneiro@agefe.pt
Web: www.knx.pt

Foundation of KNX South Africa

On October 4, a new KNX National Group was founded: KNX South Africa. The founding event was attended by the main companies in the area of Home and Building Automation and took place in Johannesburg.

After the founding documents were signed, board members

were elected as follows: Dirk Visser from ABB South Africa was elected President; Nico van der Merwe of Schneider Electric and David Gradl of AMC became Vice Presidents; and Tomislav Chris Greager from ECA South Africa was elected Secretary of the National Group.

Immediately following the foundation meeting, the Group organised its first activity – the first South African KNX Forum – jointly with KNX International. The Forum was entitled “Create a Green, Comfortable and Energy Saving Environment for Modern City Life”.



Contact: Ryan@idx.co.za
Web: www.knx.org/sa



View of the auditorium in Johannesburg, South Africa, where the countries first KNX Forum took place



Founding members of KNX South Africa

2nd Singapore Forum of KNX Technology and Application

After the great success of the first Singapore KNX Forum in 2011, there was no question about making it an annual event. Therefore, on Tuesday August 28, KNX South East Asia organised the second Singapore Forum of KNX Technology and Application. As well as focusing on the KNX technology itself, the event also looked at the development of KNX training for the next generation. Participants had the opportunity to learn about the development of KNX in South East Asia, to visit the exhibition held in parallel with the Forum, and to make contact with the major players in KNX in the emerging markets of South East Asia.

Contact: info@knx.asia
Web: www.knx.asia

The 2nd Singapore Forum of KNX Technology and Application



4th KNX Congress at Matelec trade fair

KNX Spain held its traditional KNX Congress in Madrid from October 23 – 26 as part of the leading electronic and electrical industry trade fair Matelec. The Congress spanned in an area of more than 800 m², which included the stands of several major KNX suppliers, a conference room for 160 people, and a spacious room where

delegates could meet and talk. On each of the four days of the Congress, visitors could benefit from talks by speakers from Spain and other countries. The central themes of the event were energy efficiency in new and existing buildings, and the solutions that KNX offers for smart metering, smart grids and smart cities. Other activi-

ties included round tables and open debates led by congress participants.

At the stands, visitors could learn about all the main new developments in KNX – not so much for new products as specific new problem-solving approaches that highlight the versatility of KNX as a global standard.



Contact: info@knx.es
Web: www.knx.es



The KNX Space at Matelec 2012, Madrid.



Delegates at the KNX Congress in Madrid.

KNX – how hard can it be?

In October 2012, KNX Sweden participated at the EasyFair event which took place in Stockholm. At the fair the National Group arranged a sold out seminar called “KNX – how hard can it be?” and

held the prize ceremony of the Swedish KNX Award. Jonas Svensson at Bravida, became the winner of 2012 for their excellent KNX installation in one of the world’s most prestigious sporting arenas –

Friends Arena, in Stockholm. In addition to the actions carried out at EasyFair, the very day before the fair a KNX technical workshop was organized for companies that are interested in manufacturing their



Friends Arena – the newest eye catcher in Stockholm is controlled by KNX.

own KNX products. For 2103, the most important professional fairs where KNX Sweden will participate are ELFAK and EasyFairs. Right now KNX Sweden is planning a full programme of activities for ELFAK in May 2013 and already considering the actions for EasyFair.

Contact: info@knx.se
Web: www.knx.se

KNX Swiss Project Tool: checklists for successful planning

In 2012 KNX Swiss created the Project Tool – a simple but effective planning aid for KNX Partners. The tool is available for download on the KNX Swiss website www.knx.ch.

The Project Tool is based on the planning phases defined by the Swiss Society of Engineers and Architects (SIA): preparation, design, tendering, implementation and management. The Tool includes guidelines and checklists for the various phases and trades, to make projects easier to implement. It also presents the GA-Radar tool developed by the Building Network Initiative (GNI), which helps the building owner and planner to agree on objec-

tives and reduces planning and cost risks. When used correctly, the Project Tool is a simple aid that can bring about long-term improvements in quality

and prevent errors, particularly in the early stages of a project.

Contact: info@knx.ch
Web: www.knx.ch



Aufgaben	erfüllt			Bemerkungen
	ja	nein	ausstehend	
Übersichtliche Strukturierung	<input type="checkbox"/>	<input type="checkbox"/>	<input type="checkbox"/>	
Berater und Betreuer frühzeitig einbinden	<input type="checkbox"/>	<input type="checkbox"/>	<input type="checkbox"/>	
Terminierung Projektbearbeitung	<input type="checkbox"/>	<input type="checkbox"/>	<input type="checkbox"/>	
Erstellung einer Bauleitung des Projekts	<input type="checkbox"/>	<input type="checkbox"/>	<input type="checkbox"/>	
Selbstständige Bewältigung der Einzelarbeiten	<input type="checkbox"/>	<input type="checkbox"/>	<input type="checkbox"/>	
Verständnis der Anlage	<input type="checkbox"/>	<input type="checkbox"/>	<input type="checkbox"/>	
Programmierung der Anlage	<input type="checkbox"/>	<input type="checkbox"/>	<input type="checkbox"/>	
Identifizierung der Anlage	<input type="checkbox"/>	<input type="checkbox"/>	<input type="checkbox"/>	
Aufklärung von Fehlern, Prioritätfragen	<input type="checkbox"/>	<input type="checkbox"/>	<input type="checkbox"/>	
Bearbeitung der projektualen Absprachen	<input type="checkbox"/>	<input type="checkbox"/>	<input type="checkbox"/>	
Bearbeitung der Daten von	<input type="checkbox"/>	<input type="checkbox"/>	<input type="checkbox"/>	
Planungsprüfung der einzelnen Bauelemente	<input type="checkbox"/>	<input type="checkbox"/>	<input type="checkbox"/>	
Kenntnis: integriertes Team	<input type="checkbox"/>	<input type="checkbox"/>	<input type="checkbox"/>	
Erfüllung der Pflichten gemäß	<input type="checkbox"/>	<input type="checkbox"/>	<input type="checkbox"/>	
Dokumentation: Lernzettel	<input type="checkbox"/>	<input type="checkbox"/>	<input type="checkbox"/>	
Abschließende	<input type="checkbox"/>	<input type="checkbox"/>	<input type="checkbox"/>	
Software- und Backup-Überprüfung	<input type="checkbox"/>	<input type="checkbox"/>	<input type="checkbox"/>	
Projektabschluss	<input type="checkbox"/>	<input type="checkbox"/>	<input type="checkbox"/>	

KNX city in Taiwan

Only six months after KNX Taiwan was founded, the Taiwanese National Group participated in the “Smart Green City Exhibition”. In this major exhibition of the country all members of KNX Taiwan, had the opportunity to present

their devices to the broad audience. The group’s participation in the Exhibition attracted high numbers of visitors – among them high-ranking politicians such as Taiwan’s Vice-President Wu – and raised awareness of KNX tremen-

dously. KNX Taiwan has found a strong partner in the Taiwanese Architecture and Building Center, and this partnership will result in more events.

Contact:
samuelyang623@gmail.com
Web: www.knx.org/tw



In this major exhibition of the country all members of KNX Taiwan, presented their devices to the general public.

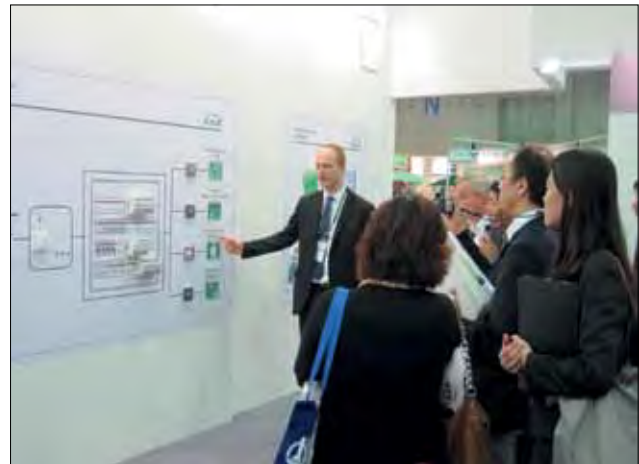

Lutz Steiner presenting the KNX Green Technology panels at the exhibition.

KNX UK at its best



KNX UK systems integrator Simon Allen takes centre stage at Building Controls South

Recent months have been very productive for KNX UK. Participation at the Building

Controls South exhibition again underlined the growth in popularity of KNX. Many new

important contacts amongst M&E consultants and specifiers were established.



Another success was the growth in KNX UK membership, including Philips joining the ranks of manufacturer members. The emphasis on membership recruitment was underpinned by a number of new initiatives, including special offers for newly qualified KNX Partners.

“In 2013, one focus will be on promoting training for potential new partners & integrators from all sectors. This is to support the industry awareness that KNX is the number one standard for home and building control,” says President Iain Gordon.

Contact: admin@knxuk.org
Web: www.knxuk.org



New Training Centres



SAUDI ARABIA
ABB Training Centre



ABB Saudi Arabia has started promoting KNX technology since 1998. It was a real challenge for a market which was conventional control oriented. Their main focus was on the consultant, despite that, they have recently decided to include in their activities, training on KNX, the worldwide standard for home and building control. Today almost all hotels, public buildings, airports, schools, universities, etc., use the KNX system. They conduct continuous

training and orientation sessions for their local customers, consultants and system integrators. They have customised a training program for universities and have successfully completed this training with one of the local universities. They are proud to now offer an official KNX certified course in their training center.

Contact: www.abb.com/sa

ITALY
CFP CNOS-FAP
DON BOSCO



CFP CNOS-FAP DON BOSCO is a Professional Training Center (high school for 14 – 17 year old students), specialised in electrical, mechanical and automotive education. They are connected with a network of thousands of electrical, mechanical and

automotive companies who welcome their students for the work placement period. They will now also offer the KNX Basic Course to their students.

Contact: www.donboscosandona.it

FRANCE
Lycée Colbert



The Colbert Lycée of LORIENT in Brittany (France) trains technicians in electrical engineering and automation as well as in mechanical engineering and design of industrial products. The KNX technology was already a part of the curriculum for this training. With the KNX certification, they now offer students the opportunity to acquire the KNX Basic Course Certificate, “KNX PARTNER”, as a part of their training. Furthermore, they plan

to train other educational institutions and give teachers an opportunity to obtain the certificate. The Colbert school is well prepared to convey KNX skills to local and regional electrical installers to bring the KNX technology into practice. For this purpose their labs are equipped with KNX devices, (Push buttons, measuring sensors, different kinds of actuators, etc.).

Contact: www.lycée-colbert-orient.com

SOUTH KOREA
Dana Corp.



Thanks to the strong support of KNX Association and Berker GmbH (Hager Group), a new training center has been established in Seoul, Korea. This new training center has many plans, especially for students in engineering schools as well as electrical engineers in the field of home

and building automation. They hope that their activities can be a strong stepping stone to the day that the Korean government adopts the KNX protocol as a part of the KS (Korean standard).

Contact: www.danaco.com

FRANCE
Domoconsulting Suisse



Domoconsulting, a global network of home automation and independent KNX training centers, is expanding again by opening a training center near Geneva. Trainings are given by professionals of the sector in a very practical way. KNX hardware from several manufacturers is used during the training course to offer a greater flexibility. Projects with a mixture

of products demonstrate the interoperability of KNX. You can obtain the KNX certification after a KNX Basic Course of five days. Due to the great success of the KNX protocol as a worldwide standard for home and building control, could this training center open its doors.

Contact: www.formation-domotique.ch

SPAIN
KNX Training Center
Spain (by Domonetio)



KNX Training Center SPAIN will provide training in three different ways: in person, blended and e-Learning (online). The e-Learning training will use an e-learning platform, eDomus, located at <http://edomus.domonetio.com>. KNX Basic and KNX Advanced Courses will use the e-

learning platform when those courses were blended. Practical part and exam will be always in person, according to the KNX Association requirements.

Contact: www.domonetio.com

BRAZIL
Eurodomotica



Eurodomotica has more than ten years of experience with KNX solutions in Portugal, having in its curriculum the implementation of some of the main KNX projects in Portugal in partnership with brands like Siemens, Hager, Merten, ABB. They are now starting a new project in Brazil, and aim to create a network of KNX system integrators with a multi-brand approach. To do so they are setting up a KNX training center to provide certified training to system integrators, architects,

engineers and designers in solutions based on KNX. They want to provide them not only with adequate training, but also with the adequate KNX products to develop innovative solutions for the commercial and residential sector. With its compact training kits equipped with KNX certified devices from Siemens, Hager and Zennio, they have the ability to provide KNX Basic Course training anywhere in Brazil.

Contact: www.eurodomotica-knx.com.br

TURKEY
infoMet
KNX Training Center



infoMET Technologies established a KNX training center in Turkey in order to transfer expertise in the field of KNX. infoMET's mission is to train a larger number of certified electricians, electrical technicians, electrical engineers which would significantly raise the level of specialists in the implementation and introduction of the KNX standard on the Turkish market. Without this they would not be able to follow the European

and global trends in the field of advanced electrical technology and automation. During the courses, infoMET provides the participants of KNX courses with quality training in a technologically equipped "training center" to gain maximum knowledge and practice.

Contact: www.infomet.com.tr

FRANCE
Luminis Services

Luminis Services is a company working through many partnerships with some major KNX manufacturers. To answer the increasing demand for KNX trainings in the region of Paris, they try to prepare the new trained, technical forces for many new

KNX projects in France. They offer seminars and training about KNX products and KNX combined courses.

Contact: tzajaczk@luminis-services.fr

AUSTRALIA
RMIT University –
School of Engineering
TAFE



RMIT has a reputation for excellence in work-relevant education and high quality research. Their courses are constantly updated to meet the changing needs of business and the broader community, and to provide students with specialised content relevant to professional and personal success in a rapidly-changing world. Whatever your reason for study, RMIT has a course to suit your needs. Through its focus on needs-driven industry solutions this new TAFE School aims to be Aus-

tralia's leading provider of cutting edge technology-focused training and education solutions in engineering. The School's programs provide a strong vocational orientation, clearly recognized and strongly supported by industry. The School goes beyond the technological and theoretical content of more traditional programs and places special emphasis on developing our students' personal qualities.

Contact: www.rmit.edu.au

CHILE
Schneider Electric Chile



After several years developing projects with KNX solutions, the current training center in Schneider Electric Chile, includes among its activities, a KNX training center for KNX Basic and Advanced Courses. These courses will be taught in Spanish and English, and aim to meet local needs, as well as also being a reference and training alternative for Central and

South America. Schneider Electric Chile Training Center is the first KNX training center in Chile, and also the first one in America within Schneider Electric. During May 2012, 14 new partners were certified as KNX Partners.

Contact: www.schneider-electric.cl

POLAND
Polskie Centrum Szkolen KNX



Polskie Centrum Szkolen KNX (Wrocław) – Training center is located in a residence equipped with KNX. There are five students laboratories where practical classes are held. Trainings are given by an expe-

rienced teaching staff, with the necessary pedagogical diplomas and practical experience gained with the KNX system.

Contact: www.knxpolska.org

TAIWAN
Taiwan Architecture & Building Center



TABC provides the testing, inspection, evaluation, and certification of building materials and construction technologies both for the government and the private sectors. In order to enhance building construction qualities and better living environment, TABC assists and promotes the developments of new construction techniques, methods, and materials as well as bridging various sectors. Since its inception, TABC has presented its influentially professional image in reviewing and assessing building

materials and technologies under the principles of integrity, fairness, and openness to cooperate with governmental policies in the industry. TABC also organises professional conferences, seminars, training programs, and cooperative ventures with mass media to promote various activities and strengthening services to the industry and the general public.

Contact: www.secta-taiwan.com.

New KNX Flyer: KNX ETS eCampus!



The click to success!

Building automation with KNX has a great future – it is a business opportunity not only for professionals such as system integrators but also for newcomers. The newly developed ETS eCampus tool from KNX can signify the first step along the path to success. The Flyer is now available for you. You can download it from the KNX website.



More information:

<http://www.knx.org/downloads-support/downloads/>

KNX Association
De Kleetlaan 5 Bus 11
B- 1831 Diegem-Brussels
Belgium

General contact:
Tel.: +32- (0)2 - 775 85 90
Fax.: +32- (0)2 - 675 50 28
E-mail: info@knx.org

www.knx.org

Culmination of knowledge exchange

KNX Scientific Conference this year was hosted by University of Las Palmas, Gran Canaria



Since KNX adopts the approach of giving all KNX Scientific Partners the possibility of hosting the bi-annual conference, this year the honor was given to the University of Las Palmas, Gran Canaria. The two full days of know-how exchange between the KNX universities, research centers and the KNX manufacturers were attended by delegates from all over Europe as well as a delegation from the ORT University in Uruguay.

On the first day, papers were presented on new KNX system components, the scheduled KNX RF extensions for ETS support, KNX Communication Security, KNX and Webservices, Android based solutions for KNX and other client applications.

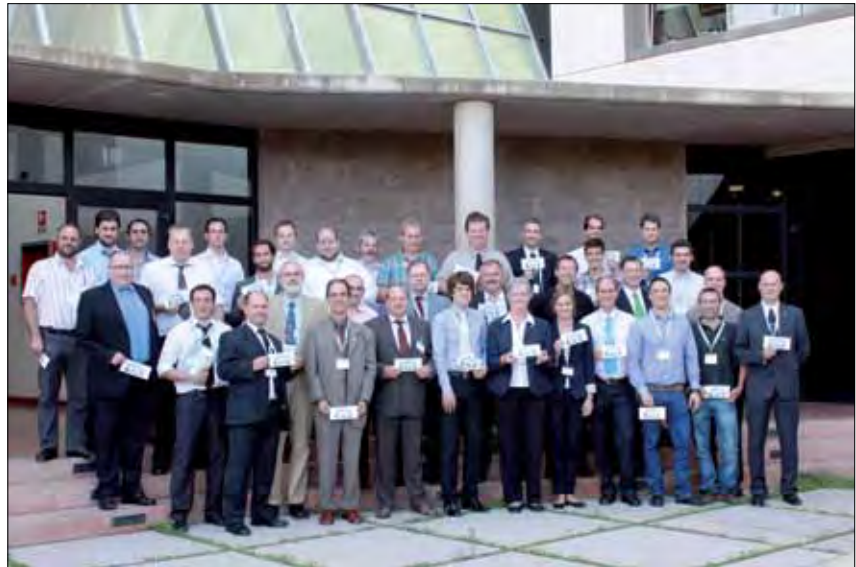

The delegates in the courtyard at the Tafira Campus of the university.

The second day was split up in three parts:

- In the last two sessions, the KNX Scientific Partners presented their research work on interfacing KNX to other systems (LOGO!, LabView and ANT) as well as the use of KNX for new application domains like demand side management, advanced lighting control, energy efficiency in buildings in the tourist industry and fire safety systems.
- Contrary to the last edition of the KNX Scientific Conference, KNX had this year opted to award the KNX Scientific Award to the best presentation: both the program committee as well as the attendants during the conference casted their votes on each presentation, evaluating them on innovation, added value for KNX, clarity and overall quality. The highest score was awarded to the presentation of Prof. Kastner of the Vienna University of Technology for his presentation on the topic of “seamless integration of KNX into constrained RESTful environments”. KNX congratulates the professor, rewarding him with the KNX Scientific Award trophy and 3000 € in prize money.
- Last but not least, the delegates were invited to a field trip to the AENA flight control center of the Las Palmas airport, where the new Engineers Building has been equipped with KNX and where the delegates got a thorough inside view in aviation control.



Andreas Fernbach of the Vienna University of Technology, collecting the KNX Scientific Award on behalf of Professor Wolfgang Kastner for the best 2012 KNX Scientific Conference Presentation, together with Hazel Johnson (responsible for the KNX Scientific Partnership), Catherine Schommer (the successor to Hazel Johnson) and Joost Demarest (KNX Director).

Contact: info@knx.org





New Scientific Partners



ROMANIA
Technical University
of Cluj Napoca



The Department of Automation is part of the Faculty of Automation and Computer Science of the Technical University of Cluj-Napoca. TU-CN is one of the most prestigious higher education institutions in Romania and dates back to 1920. The specialisation in Automation and Applied Informatics prepares students for a challenging and rewarding career in a dynamic environment. Academic staff members provide high-standard courses oriented towards control systems and their ap-

plications in various areas of technology. The main research areas of the department are: adaptive and predictive control, robust control, robot control, digital signal processing for adaptive filtering, intelligent systems, modeling and simulation of distributed parameter systems, reliability, testing, design for testability, system identification, building automation, urban and railway traffic control.

Contact: valentin.sita@aut.utcluj.ro

GERMANY
FZI Forschungszentrum
Informatik



FZI supports companies and public institutions in the transfer of new findings of scientific research in the area of IT, engineering or business sciences into commercial success. On 2000 m² FZI Karlsruhe has consolidated its issue-focused laboratories for the research and development of new products and services into a until recently nationwide unique technology transfer center. The FZI House of Living Labs will support you during your application research. This integrated research

environment allows you to put your approaches in the field to the test. The FZI Living Lab Smart Home creates a research infrastructure for the development and evaluation of smart home technologies and application scenarios. In this infrastructure, intelligent home technologies (including KNX) and their integration in the private home environment are researched and developed.

Contact: nosales@fzi.de

CHILE
Universidad Tecnológica
de Chile – INACAP



INACAP Technical College is the largest technical education institution in Chile. It has over 108,000 students spread over its 25 campuses within the 15 regions of Chile. Committed to the environment, the Renca Campus is the first to use KNX system in its classrooms in order to promote the competence of students in the electrical field, safety and energy efficiency in homes. Its students learn from the very beginning the use of the technology, either

it is for Electrical, Electronic, or Automation Technology. In order to achieve this goal, its campus is going to incorporate the most modern equipment in Domotics at its laboratories. INACAP is the first technical college in Chile, and the second in Latin America to become KNX Scientific Partner.

Contact: gerald.esparza@inacapmail.cl

MACEDONIA
MIT University



МИТ УНИВЕРЗИТЕТ

The MIT University Macedonia was founded in 2007. There are six faculties at the university, which is located in the capital of Macedonia, Skopje. The faculty of computer science and technology is one of them. Its plan is to establish a KNX laboratory at the faculty where bachelor and master students can work with the KNX technology and develop KNX based projects. Also, many bachelor and master diploma thesis are expected to deal with building automation systems in the field of meas-

urement and monitoring of physical values, developing user interfaces to access KNX installations and energy management applications. Primarily, its main focus will be developing user interfaces for mobile platforms, monitoring systems for KNX sensor networks and development of libraries for KNX access in different programming languages.

Contact: orce.simov@mit.edu.mk

SOUTH KOREA Sangmyung University



The Sangmyung University in Seoul, Korea was founded about 70 years ago.

The University has many faculties that lead frontier research institutes and laboratories. One of the cutting edge research institutes is the Green Energy Institute that conducts research and development in building automation and energy areas.

Major R&D areas of the Green Energy Institute are:

Building Automation Systems:

- Internet based integrated field control instruments
- Web based integrated surveillance systems

- Wireless sensor systems and wireless communication systems
- *Building Energy Management Systems*
- BEMS instrument systems
- BEMS standards
- BEMS strategy in Korea

As a leading BAS R&D institute in Korea, KNX Scientific partnership is a great educational and business opportunity for the university to extend its research areas.

Contact: parkjwha@gmail.com

SPAIN Universidad Carlos III de Madrid



The System Engineering and Automation department of the Carlos III University in Madrid, Spain manages a building automation Lab, in which the Building Automation course (Aplicaciones de la Automatica Edificios) is taught and R&D activities related to the application of automation in build-

ings and the interaction between mobile and humanoid robots and smart buildings are run. The lab is equipped with equipment from several technologies, where KNX is the key protocol.

Contact: alvaro.jaramillo@uc3m.es



KNX Solutions flyer now printed!

KNX is used in all types of homes and buildings, for many purposes and in an efficient way. The flyer “KNX Solutions” shows 15 cases in which KNX can be used, the advantages of KNX, as well as all the outstanding projects from the latest edition of the KNX award. The flyer is currently available in five different languages. Interested? You can download it from the KNX website.

Link: <http://www.knx.org/downloads-support/downloads/>



More information under:

KNX Association
De Kleetlaan 5 Bus 11
B- 1831 Diegem-Brussels
Belgium

General contact:
Tel.: +32- (0)2 - 775 85 90
Fax.: +32- (0)2 - 675 50 28
E-mail: info@knx.org
Web: www.knx.org

www.knx.org

KNX Userclub / KNX Professionals



KNX Userclub CIS and Baltic Now Founded!

KNX Association is growing exponentially and the proof of this fact is the new KNX Userclub CIS and Baltic. This KNX Userclub will be active in the area of the Commonwealth of Independent States (CIS) and Baltic countries. The association will use this Userclub platform to spread and share information, as well as to share experiences amongst the KNX professionals and users in the regions. If you are interested, please follow the link and visit the site. The acceptance has been very high since 58 members were the founding members. This facilitated the next



Website of the Userclub CIS and Baltic

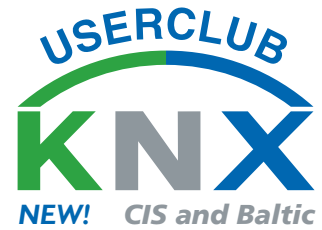

steps, such as: the launch of a new website (www.knx-club.ru); a cooperation agreement with the magazine "Building Automation" (a publication with more 1,700 subscribers); and than agreements with other media channels.

Contact:

www.knx.org/knx-partners/uc/list/

KNX Userclub Hungary Supporting International Competitions

During 2012, the main activity of the KNX Userclub Hungary was focused on helping the Hungarian students from BME (Budapest Technical University) in the project "Oodo house".

This project was created to participate in Solar Decathlon Europe 2012 international competition among universities with the objective to design and build houses that consume few resources as possible and naturally produce minimum waste product during their life cycle. This is the reason why KNX technology was considered for the home automation system. In particular, lighting, heating, HVAC were controlled by KNX via a visualisation.

As result, the "Oodo house"

reached 6th place position in the global competition and also ranked 2nd place in the category "Engineering and Construction" (where KNX was conceived).

Last but not least, the "Oodo

house" is already back in Hungary where it has rebuilt in Budapest in order to become a showroom for anyone interested can visit.

Contact: www.installateur.hu



The Hungarian team at the "Oodo house" (frontal view)

Alpha-X wins KNX Professionals Award 2012

The KNX project which is operated by iPad in the temporary operation complex at the hospital in Geldrop is winner of the KNX Professionals Award 2012. "Alpha-X Domotica" creates an integral building automation for operating the lighting and climate in the operating theatres.

The winner of the KNX Professionals Award 2012 was announced on November 23 during the trade fair "Home Automation and Smart Living" in Eindhoven. The "Alpha-X Domotica" project is a wonderful example of the enormous



The winners at the award ceremony



range of the KNX protocol. The second place was for the company Domoticom, which had submitted a project with the total integration of installations in a luxurious villa. The third place was for Domotica Design where a project for energy monitoring was central.

Contact: www.knx-professionals.nl

A Win-Win Situation at Trade Fairs

The KNX Professionals Germany planned a diverse program in the year 2012, including appointments for manufacturer visits, trainings, and taking part in various trade fairs. The manufacturer visits took place at ABB in Heidelberg and at Merten in Wiehl, and the yearly meetings were held in Nuremberg and Leipzig. A particularly important highlight, however, was the participation at the "GET Nord."

The concept for the GET Nord 2012 was to appear together with the Hamburg Electronic Guild. That was an excellent idea and proved to be a win-win situation for those taking part.

The KNX Professionals, with support from the KNX Association in Brussels, had prepared several interesting offers for the visitors, encouraging brisk attendance at their stand.



Dirk Beyer and Dieter Koch from the KNX Professionals Germany at the GET Nord.

By taking a quiz, visitors had the opportunity to win 23 ETS4 licenses at the special price of 500 Euro. An ETS4 Lite voucher could also be earned. The quiz materials were available at the manufacturer exhibit stands as well, and those electricians inter-

ested in KNX made a point of sending them directly to the Professionals. The raffle to win the licenses generated a great deal of interest. The special price of 500 Euro is a perfect opportunity for businesses to try it out with little risk.

The 100 ETS Lite licenses



particular interest in the ETS Apps.

In order to demonstrate the level of activity, a work station with a monitor had been set up. Dieter Koch and Dirk Beyer of the Professionals were very pleased with the number of contacts made each day. Indeed, 150 conversations in three days is a respectable outcome.

This was the third coordinated trade show appearance of the Professionals with the BZE (since 2008). Both parties have already agreed to work together again at the GET Nord 2014.

Contact: www.knx-professionals.de

KNX at International Conferences / Fairs

Milano (Italy)

National KNX Awards in Italy



The ceremony of the Award organised by the National Group KNX Italia was held on December 10 2012 in Milan. On this occasion, 21 projects related to KNX were competing for a prize in five categories:

- The winner of the category best KNX project for energy efficiency was the project “Sicilian Home Automation”.
- The “Devero Hotel” won the best KNX project for welcome structures.
- The winner in the category best KNX project for public administration was the Centro Polifunzionale Dambel.

- “Una casa per Luca Barisonzi” won the best KNX social project.
- Finally, the prize for the best KNX national project was attributed to “Cascina Rubattera”.

In addition three special mentions for particular KNX projects went to the projects Auditorium “Il Castello” de l’Aquila, Montain Lodge Tamersc and “3e Lab Il Polo Positivo”.

Contact:
segreteria@konnex.it

Anapolis (Brazil)

KNX Workshop in Anapolis



Shortly after being founded, KNX Brazil integrators working with different technologies for home and building control in the country had the opportunity to participate in seminars that highlighted the basics of KNX. Notable seminars were the “Introduction to KNX – Applications and Solutions” organized by Eurodomótica, a manufacturer independent

KNX Training Centre, in which basic KNX concepts were explained to an audience of 40 people at CREA (Regional College of Engineering and Architecture of Anapolis) as well as another session at the SENAI, the main technical university in Brazil.

Contact: josegamboa@eurodomotica-knx.com.br

Istanbul (Turkey)

KNX National Groups Conference at the Bosporus

The VIII International KNX National Group Conference was held in October 2012 in Istanbul (Turkey). As usual, presidents and secretaries of the National Groups and KNX Association, met in order to present and share their latest experiences with regards to the marketing and communication activities in their local markets.

The key topic of the event was the internationalization of KNX to Asia, making the Turkish capital the perfect place as a symbol that connects Europe with Asia.

During the second day of the meeting, the concept of KNX



Representatives of the KNX National Group Conference in Istanbul

City was showed to the audience which was welcomed by all national participants. This concept tries to explain how the control of homes and buildings is beyond the control of individual installations, creating niches well structured (from a technical standpoint) and connected. The conference put also the emphasis in future actions such as: the expected new KNX Website, technical KNX workshops for potential manufacturers of KNX devices, ETS Apps, etc.

Contact:
www.knx.org/national-sites

Brussels (Belgium)

KNX Technical Workshop in Belgium

On Thursday January 17, KNX Belgium, in collaboration with KNX Association, welcomed more than 20 participants for its edition of the KNX Technical Workshop at the NH Hotel in Diegem. After welcoming the participants, Tom Van Renterghem as President from KNX Belgium gave the floor to Joost Demarest, Chief Financial Officer at KNX, to inform the participants about the advantages of KNX and the last year's growth figures of KNX worldwide. Kurt Vochten from Elektriciteit Vochten NV and Hannelore Verdonckt from Elektromat (both members of the KNX Professionals Belgium) presented a residential and a tertiary Belgian project. In the afternoon, Joost De-



Tom Van Renterghem, President from KNX Belgium, during his presentation at the workshop.

marest again went on stage to inform about the procedure how to develop a KNX device, after which Klaas Arnout from the Belgian KNX Member company basalte presented their success case in developing KNX products. In conclusion, Christophe Parthoens, Support Engineer

at KNX Association, gave a presentation about the new ETS Apps concept and explained how to become an ETS App developer.

Contact: info@knx.be

Brussels (Belgium)

KNX offers seven new national pages



Interest in KNX, the worldwide standard for home and building control, is growing at a great pace all around the world. This also resulted in the foundation of many new KNX National Groups in recent months. Therefore KNX Association now offers new national pages so local KNX communities can be better informed about KNX in their own languages and can check the local KNX news. The following national pages are now being offered through the KNX website: Argentina, Brazil, India, Korea, Middle East, South Africa and South East Asia. To get access to the local webpages, click on the language flags showed on top of the KNX Website (www.knx.org).

Contact: info@knx.org

Blieskastel (Germany)

German KNX Working Group Training meets at Hager in Blieskastel

Delegates from the German speaking KNX certified training centers and delegates from local manufacturers met up at the Hager premises in Blieskastel on November 16 2012, to discuss:

- A proposed update of the KNX requirements for training centers, amongst others including explicit requirements for KNX theoretical online training;
- An update of the training documentation, both of the KNX Basic Course but also of the KNX Advanced Course.

As for the update of the topics of the KNX Advanced



The picture shows the entire group with delegates from German speaking training centers and from German KNX members.

Course, new chapters have been developed on the topics of "KNX and Smart Metering/Smart Grid" as well as "KNX and Multimedia" and the program of the KNX Advanced Course adapted

accordingly. Following the launch of the ETS App concept, the content as well as the title of the chapter "Supplementary Tools" was changed to "ETS Apps". Also the chapter "Visualisation"

was revised. All chapters will soon be available for the KNX certified training centers via their KNX Online Shop account.

Contact: info@knx.org

Guangzhou (China)

Renewed KNX Tutor Course held in P.R. China



Joost Demarest, CTO and CFO of KNX Association, and the students

KNX Association continues its efforts to increase the number of training centers operating at different locations in the vast marketplace

of the P.R. of China by the organization of the third consecutive KNX Tutor Crash Course almost in one year. After having been hosted

by the companies Videostar and HDL in Guangzhou, the KNX Tutor Course was this time organised in the city of Nanjing at the premises of

the KNX member company TIANSU.

Twenty persons attended the two days intensive training that was concluded with one day of theoretical and practical exam. Next to a high number of participants from TIANSU, participants from the following companies have sent delegates to the course:

- Nanjing Airport Electro-mechanical Co. Ltd;
- Shanghai Fucheng Intelligent Engineering Co. Ltd;
- Beijing Huaxia Keshu International Intelligent Technology Co. Ltd;
- Huangzhou Metis Intelligent Technology Co. Ltd.
- Shanghai Longchuang Automation Control System Co. Ltd.
- Shanghai Engineering Technology University.

Contact: info@knx.org

Bangalore (India)

KNX Association organises second Tutor Crash Course in India



KNX Association organises second KNX Tutor Crash Course in India

In the beginning of October, KNX Association organised the second KNX Tutor Course in India, this time at the Sadashivanagar club in the city of Bangalore. At this edition local representatives from the manufacturers Schneider Electric, ABB and JUNG participated, next to local system integra-

tors Satphashree Engineers and Consultants and Light and Magic Automation. The picture shows four represented companies together with the KNX tutor, Joost Demarest of KNX Association.

Contact: info@knx.org

Brussels (Belgium)

New Flyer: How to become an ETS App Developer

An ETS App is an add-on software program that is used together with ETS. The purpose of an ETS App is to extend the functionality of the ETS Software tailored to the needs of the KNX system integrators. Any existing software can be adapted to the ETS App interface by using the ETS SDK. Do you already have an idea for an ETS App? Are you innovative? Then you are ready to start! To see all the steps to follow and the advantages of becoming an ETS App Developer, read the new flyer.

Contact: etsapps@knx.org

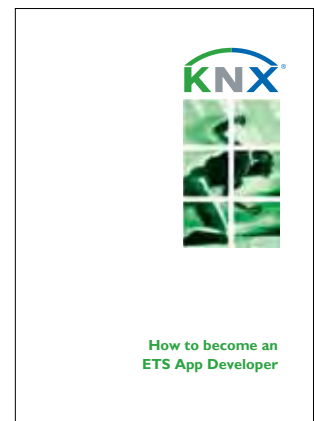

Brussels (Belgium)

Three new national KNX Journals now available



In addition to the second edition of the KNX Journal of 2012 was published, KNX Association circulated three national KNX Journals related to the markets of Belgium, Russia and Spain. These special editions are beneficial for

the KNX National Groups because of helping to spread the news about KNX activities (internationally and also nationally) in the specific countries.

Link: www.knx.org/news-press/knx-journal/

Brussels (Belgium)

New release of ETS4



ETS, the Engineering Tool Software; a manufacturer independent configuration tool software to design and configure intelligent home and building control installations with the KNX system, released a new version last December. The ETS4.1.6 version is compatible with the Microsoft Windows™ 8 operating system. Furthermore, this new version comes along with in four new languages: Turkish, Finnish, Czech and Portuguese. The users can update to this version via the ETS online update function.

Contact: info@knx.org



Rexel Fair

France
5. – 6. 6. 2013 (Marseille)
20. – 21. 11. 2013 (Nantes)
Events with the focus on the electronics sector
www.knx.fr



Guangzhou Electrical Building technology

9. – 12. 6. 2013
Guangzhou (China)
Event that aims at brand-building and invites professional buyers
www.building.messefrankfurt.com.cn



V Congresso KNX

26. – 28. 6. 2013
Barcelona (Spain)
Congress organized by KNX Spain
www.knx.es

KNX Conferences / Fair Schedule

2013



ISH
12. – 16. 3. 2013
Frankfurt (Germany)
Trade fair for bathroom, building, energy, HVAC, renewable energies
www.ish.messefrankfurt.com



BCIA Awards 2013
9. 5. 2013
Solihull (United Kingdom)
British Construction Industry Awards
www.bcia-awards.co.uk



elfack 2013
13. – 17. 5. 2013
Gothenburg (Sweden)
The biggest meeting place for the Nordic electrical sector
www.elfack.com



Worldskills 2013
2. – 7. 7. 2013
Leipzig (Germany)
The world's largest international skills competition
www.worldskillsleipzig2013.com



Eltefa 2013
20. – 22. 3. 2013
Stuttgart (Germany)
Trade fair mainly oriented to the electrical industry sector
www.eltefa.de



Power Days Austria
13. – 15. 5. 2013
Salzburg (Austria)
Home and building automation fair
www.power-days.at



KNX Roadshow China
16. – 17. 5. 2013 (Beijing)
20. – 21. 5. 2013 (Shanghai)
23. – 24. 5. 2013 (Guangzhou)
27. – 28. 5. 2013 (Chongqing)
Nationwide event to promote KNX in the main cities of China
www.knx.cn



KNX Belgium Top Event 2013
5. 9. 2013
Sint-Katelijne-Waver (Belgium)
One day KNX event organized by KNX Belgium
www.knx.be



BEX Asia 2013

11. – 13. 9. 2013
Singapore (Singapore)
Building exposition in South East Asia focused on green building
www.bex-asia.com



Predialtec 2013

11. – 13. 9. 2013
Sao Paulo (Brazil)
The biggest Brazilian trade fair with focus on audio/video and building automation
www.predialtec.com



Elektrotechnik 2013

11. – 13. 9. 2013
Dortmund (Germany)
Leading regional trade fair for electrical engineering and industrial electronics
www.westfalahallen.de/messen/elektrotechnik/index.php



Shanghai Intelligent Building Technology

25. – 27. 9. 2013
Shanghai (China)
Event that aims at brand-building and invites professional buyers
www.building.messefrankfurt.com.cn



Elektrotechnik 2013

30. 9. – 4. 10. 2013
Utrecht (The Netherlands)
The most important trade fair for the installer industry
www.elektrotechnik-online.nl



Hem & Villa

(Sweden)
3. – 6. 10. 2013 (Stockholm)
24. – 27. 10. 2013 (Gothenburg)
The largest do-it-yourself trade fair
www.hemochvilla.se



Autumn Fair 2013

12. – 20. 10. 2013
Luxembourg (Luxembourg)
A must-attend event focused on products and services for anyone with building, renovation or decoration plans in mind
www.automne.lu



interclima+elec 2013

4. – 8. 11. 2013
Paris (France)
An opportunity to discover the most innovative solutions which combine energy efficiency and comfort
www.interclimaelec.com



Interlight Moscow 2013

5. – 8. 11. 2013
Moscow (Russia)
International trade fair for lighting, electrical engineering, home and building automation
www.interlight.messefrankfurt.ru



Biel light+building

5. – 9. 11. 2013
Buenos Aires (Argentina)
Biennial international trade fair for electrical engineering, electronics and lighting
www.biel.com.ar



KNX Colloquium

8. 11. 2013
Frankfurt am Main (Germany)
One day KNX event organized by KNX Germany
www.knx.de



Beurs Domotica en Slim Wonen

20. – 21. 11. 2013
Eindhoven (The Netherlands)
Trade show mainly based on home and building electronic systems
www.beursdomoticaenslimwonen.nl

Imprint

KNX Journal international

The KNX Journal is the international magazine for home and building control based on KNX technology. Experts, practitioners and professionals show the way in applying and developing the KNX standard – from home and building control trends to devices and application projects; from the KNX members and partners to useful information on event stand and publications. Special attention is given to members and activities of the KNX Association international and their national groups.

Distribution

This bi-annual and bi-lingual Journal (English/German) can be ordered free of charge by all members, partners (installers, scientific, training centres, associated, national groups) and by media representatives of KNX Association international. Order the KNX Journal by Email from knx-journal@knx.org.

Online Distribution

The KNX Journal international is posted as a Portable Document Format (PDF)-File to www.knx.org/news-press/knx-journal/.

Editor

KNX Association cvba
De Kleeftan 5 Bus 11
B-1831 Diegem - Brussels, Belgium
Phone: +32 (0) 2 775 85 90
Fax: +32 (0) 2 675 50 28
Email: info@knx.org
URL: www.knx.org

Editorial Office:

Redaktion KNX Journal
Friedrich-Wolf-Str. 16 A
12527 Berlin
Germany
Phone: +49 (0) 30 64 32 62 79
Fax: +49 (0) 30 64 32 62 78
Email: knx-journal@knx.org
URL: www.knx.org/news-press/knx-journal/

Print edition:

80,000 copies

Picture credits:

KNX Association cvba, editorial office and specified companies

Copyright

Reproduction of contributions only with permission of the publishing house under detailed source data. For unsolicited sent-in manuscripts and entries the publishing house does not take any responsibility. The photos are provided from the respective companies. Brands used in this magazine without guarantee of the free usefulness. Texts, illustrations and technical data are carefully compiled, nevertheless errors cannot completely be excluded. The publishing house and the authors can neither take a legal responsibility nor any adhesion for incorrect data.

KNX® and ETS® are registered trademark of KNX Association cvba, Belgium.

Your partners



Mr. Heinz Lux
CEO, Spokesman
heinz.lux@knx.org
Phone: +32 - (0)2 - 775 85 90



Mr. Joost Demarest
CFO, CTO
joost.demarest@knx.org
Phone: +32 - (0)2 - 775 86 44



KNX Association
De Kleetlaan 5 Bus 11
B - 1831 Diegem-Brussels
Belgium

General contact:
Phone: +32 - (0)2 - 775 85 90
Fax: +32 - (0)2 - 675 50 28
Email: info@knx.org
Web: www.knx.org



Mr. Serge Creola
Sales & Support Manager
sales@knx.org
Phone: +32 - (0)2 - 775 85 90

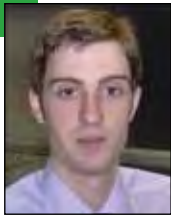

Mr. Casto Canavate
Marketing Manager
casto.canavate@knx.org
Phone: +32 - (0)2 - 775 85 91



Mr. André Hänel
System & Tool Manager
andre.haenel@knx.org
Phone: +32 - (0)2 - 775 85 90



Mr. Ufuk Unal
Certification Manager
ufuk.unal@knx.org
Phone: +32 - (0)2 - 775 86 53



Mrs. Angelique De Scheemaecker · Sales
sales@knx.org
Phone: + 32 (0)2 - 775 85 90



Mr. Thibaut Hox
Marketing
thibaut.hox@knx.org
Phone: + 32 (0)2 - 775 85 99



Mr. Steven de Bruyne
System Architect
steven.debruyne@knx.org
Phone: +32 - (0)2 - 775 86 47



Ms. Catherine Schommer
Administration
catherine.schommer@knx.org
Phone: +32 - (0)2 - 775 86 45



Mr. Christophe Parthoens
Support Engineer
support@knx.org
Phone: +32 - (0)2 - 775 85 90



Mr. Christian Stahn
Marketing
christian.stahn@knx.org
Phone: +32 - (0)2 - 775 86 48



Mr. Vassilios Lourdas
System Engineer
vassilios.lourdas@knx.org
Phone: +32 - (0)2 - 775 86 40



Sales
KNX Tools Online Shop:
<https://onlineshop.knx.org>



Tool Support
KNX Online Support:
<https://onlineshop.knx.org>

Follow us:



facebook



LinkedIn





The worldwide STANDARD for home and building control

KNX members

300 manufacturers from 34 countries

